



**Reference Manual**

**Governing Fundamentals  
and Power Management**

**This manual replaces manuals 01740 and 25195.**

**Manual 26260**

Woodward Governor Company reserves the right to update any portion of this publication at any time. Information provided by Woodward Governor Company is believed to be correct and reliable. However, no responsibility is assumed by Woodward Governor Company unless otherwise expressly undertaken.

© Woodward 2004  
All Rights Reserved

# Contents

<b>CHAPTER 1. INTRODUCTION TO GOVERNING .....</b>	<b>1</b>
Introduction .....	1
Other References .....	1
What is a Governor?.....	1
Governor Components .....	3
Development of the Modern Governor System.....	4
<b>CHAPTER 2. HYDRO-MECHANICAL GOVERNORS .....</b>	<b>5</b>
Basic Hydro-mechanical Governor Components .....	5
The Speeder Spring .....	5
Thrust Bearing .....	6
Flyweights.....	6
Pilot Valve Plunger and Bushing .....	8
Oil Pumps .....	9
Direction of Rotation .....	10
The Servo (Power) Piston .....	11
<b>CHAPTER 3. DROOP .....</b>	<b>13</b>
Introduction .....	13
Why Is Droop Necessary?.....	13
Speed Droop Operation .....	14
Uses Of Droop.....	15
Isolated Systems .....	18
<b>CHAPTER 4. LINKAGE.....</b>	<b>22</b>
General.....	22
Governor Travel.....	23
Linear Linkage Arrangements .....	24
Non-Linear Usage .....	25
<b>CHAPTER 5. MAGNETIC PICKUPS.....</b>	<b>26</b>
Introduction.....	26
<b>CHAPTER 6. LOAD SENSING, LOAD SHARING, BASE LOADING .....</b>	<b>30</b>
Load Sensing.....	30
Load Gain Adjust Potentiometer .....	30
Balanced Load Bridge .....	31
Power Output Sensor .....	34
Isochronous Base Load.....	34
<b>CHAPTER 7. SYNCHRONIZATION .....</b>	<b>39</b>
What Is Synchronization?.....	39
Why Is Synchronization Important?.....	42
How Is Synchronization Accomplished? .....	42
Prediction of the Worst Case Phase Angle Difference ( $\phi$ ) at the Instant of Breaker Closure.....	44

# Contents

<b>CHAPTER 8. MANAGING POWER FOR THE DESIRED RESULT .....</b>	<b>46</b>
Peaking or Peak Load Control .....	46
Cogeneration .....	51
Single Engine AGLC–Base Load Control.....	51
Isolated Bus Isochronous Load Sharing System .....	57
Multiple Engine AGLC–Base Load Control .....	60
Automatic Paralleling System (2301A) to a Utility Using a Process-Import/Export Control .....	63
Automatic Paralleling System (2301A) to a Utility Using an Automatic Power Transfer And Load (APTL) Control.....	66

## Illustrations and Tables

Figure 1-1. The Driver is the Governor.....	2
Figure 1-2. Speed Balance.....	2
Figure 2-1. Speeder Spring .....	5
Figure 2-2. Speeder Spring Deflection .....	6
Figure 2-3. Hydraulic Governor Ballhead.....	6
Figure 2-4. Flyweight Action .....	7
Figure 2-5. Flyweights to Minimize Friction.....	7
Figure 2-6. Pilot Valve Operation Shown “On Speed” .....	8
Figure 2-7. Oil Pumps.....	9
Figure 2-8. Accumulator and Governor Relief Valve.....	10
Figure 2-9. Pump Rotation .....	10
Figure 2-10. Spring Loaded Servo Piston .....	11
Figure 2-11. Differential Power Piston.....	12
Figure 3-1. Response Curves of Governor without Droop or Compensation .....	13
Figure 3-2. Droop Feedback .....	14
Figure 3-3. Compensated Governor Schematic.....	15
Figure 3-4. Comparison of 3% Droop Speed Settings for 50% and 100% Load ..	16
Figure 3-5. 3% and 5% Droop Curves .....	16
Figure 3-6. Droop Mode .....	17
Figure 3-7. Swing Machine.....	18
Figure 3-8. Droop Units .....	19
Figure 3-9. Base Load with 5% Droop .....	20
Figure 3-10. Schematic of Droop Governor .....	21
Figure 4-1. Linear Fuel Control .....	22
Figure 4-2. Non-Linear Fuel Control.....	23
Figure 4-3. Correct Use of Governor Travel.....	23
Figure 4-4. Nonlinear Carburetor Linkage.....	25
Figure 5-1. Magnetic Pickup.....	26
Figure 5-2. Low Reluctance Gear Position .....	27
Figure 5-3. High Reluctance Gear Position.....	27
Figure 5-4. Magnetic Pickup and Gear Dimensions.....	28
Figure 5-5. Generated Waveforms .....	29
Figure 6-1. Generator Load Sensor .....	30
Figure 6-2. Balanced Load Bridge.....	31
Figure 6-3. Basic Load Sensing Block Diagram.....	32

## Illustrations and Tables

Figure 6-4. Load Sharing Diagram .....	36
Figure 6-5. Load Sharing Block Diagram .....	37
Figure 6-6. Multiple Load Sharing Block Diagram.....	38
Figure 7-1. Number of Phases Must Match Number Of Phases.....	39
Figure 7-2. Phase Rotation Must be the Same Rotation Of Phases.....	40
Figure 7-3. Voltage Difference (Generator to Generator) .....	40
Figure 7-4. Voltage Difference (Generator to Bus) .....	40
Figure 7-5. Frequency Difference.....	41
Figure 7-6. Phase Difference .....	41
Figure 7-7. Checking Phase Match .....	43
Figure 7-8. Checking Phase Rotation and Match .....	43
Figure 7-9. Phase Angle Relationship.....	45
Figure 8-1. "Peaking" or Peak Load Control .....	47
Figure 8-2. Base Loading .....	48
Figure 8-3. Peak Shaving .....	48
Figure 8-4. Import Power.....	49
Figure 8-5. Import Power (Constant Level) .....	49
Figure 8-6. Export Power .....	49
Figure 8-7. Export Power (Constant Level).....	50
Figure 8-8. Import/Export Control.....	50
Figure 8-9. Zero Import/Export .....	50
Figure 8-10. Synchronizing to Utility or Plant Bus.....	53
Figure 8-11. Synchronizing Gen Set to Plant Bus or to Utility .....	54
Figure 8-12. Single Engine AGLC Base Load.....	55
Figure 8-13. Connections for Single Engine AGLC Base Load System .....	56
Figure 8-14. Using AGLC for Soft Load, Soft Unload, and Base Load to an Isolated Bus for Isochronous Load Sharing .....	58
Figure 8-15. Connections Used with AGLC for Soft Loading, Unloading, and Base Loading with Isochronous Load Sharing Against an Isolated Bus.....	59
Figure 8-16. Using the AGLC to Base Load Multiple Engines to a Utility .....	61
Figure 8-17. Connecting an AGLC to Base Load Multiple Engines to a Utility ....	62
Figure 8-18. Using Process-Import/Export Control to Automatically Parallel .....	64
Figure 8-19. Connecting Process-Import/Export Control to Paralleling System ..	65
Figure 8-20. Using APTL in Automatic Paralleling System.....	67
Figure 8-21. Connecting APTL in Automatic Paralleling System.....	68



# Chapter 1.

## Introduction to Governing

### Introduction

This manual combines former Woodward manuals 25195 (Governing Fundamentals) and 01740 (Power Management). Chapters 1–5 cover basic governing, and chapters 6–9 cover the principles of power management.

### Other References

Other useful references you might find useful can be found on our website ([www.woodward.com](http://www.woodward.com)):

Pub. No.	Title
25075A	Commercial Preservation Packaging for Storage of Mechanical-Hydraulic Controls
25070D	Electronic Control Installation Guide
25014C	Gas Engine Governing
25179C	Glossary of Control Names
50516	Governor Linkage for Butterfly Throttle Valves
82715H	Guide for Handling and Protection: Electronic Controls, PCBs, Modules
82510M	Magnetic Pickups and Proximity Switches for Electronic Controls
25071J	Oils for Hydraulic Controls
83402	PID Control
83408	PLCs for Turbine Control Systems
50511A	Prediction of Phase Angle at Breaker Closure
50500D	Simplified Unloading Scheme for Electric Governors
01302	Speed Droop & Power Generation
51214	Work versus Torque

In addition, all product specifications, brochures, catalogs, and application notes (as well as many technical manuals) can be found on the website.

### What is a Governor?

All power sources must be controlled in order to convert the power to useful work. The essential device which controls the speed or power output of an engine, turbine, or other source of power is called a **governor**. For simplicity, we'll call the source of power a **prime mover**.

A governor senses the speed (or load) of a prime mover and controls the fuel (or steam) to the prime mover to maintain its speed (or load) at a desired level. In some cases the governor controls other factors that determine the speed or load of the prime mover. In all cases, **a governor ends up controlling the energy source to a prime mover to control its power so it can be used for a specific purpose.**

**Example**—If you’ve ever driven a car, you’ve functioned as a governor when you control the car’s speed under varying driving conditions.

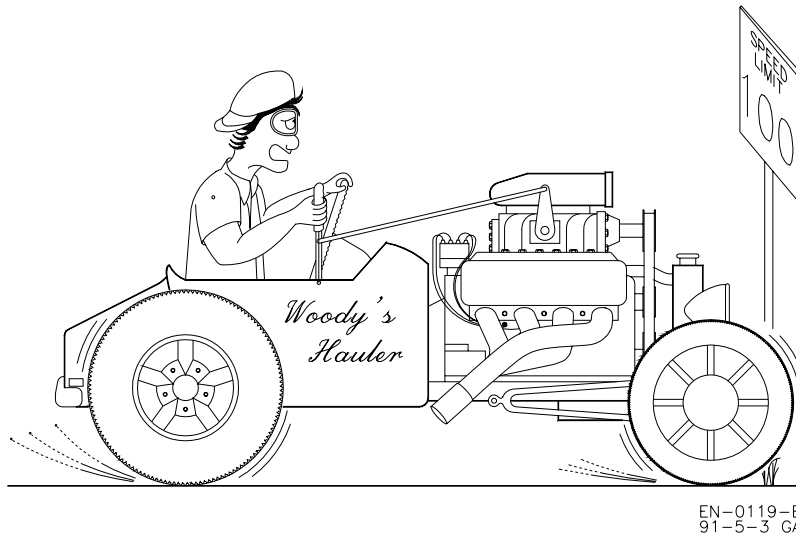

Figure 1-1. The Driver is the Governor

The driver (governor) adjusts the fuel to maintain a desired speed. If the speed limit is 100 (this is the desired speed), you check the speedometer (the car’s actual speed). If actual speed and desired speed are the same, you hold the throttle steady. If not equal, you increase or decrease throttle position to make the desired speed and the actual speed the same (see Figure 1-2).

As the car starts uphill, the load increases and actual speed decreases. The driver notes that actual speed is less than desired speed and moves the throttle to increase speed back to the desired speed at the increased load.

As the car goes downhill, the load decreases and actual speed increases. The driver notes that actual speed is greater than desired speed and decrease the throttle to return to the desired speed with the decreased load.

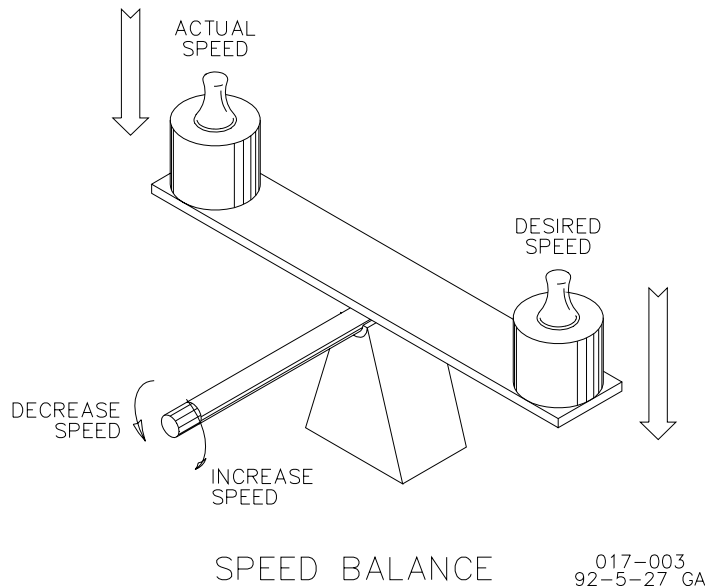

Figure 1-2. Speed Balance



If your car has a cruise control, the cruise control is a simple governor.

## Governor Components

All governors have five fundamental components:

- A way to set the desired speed. (The driver sets the desired speed mentally.)
- A way to sense actual speed. (The driver refers to the speedometer).
- A way to compare the actual speed to the desired speed. (The driver compares the two items mentally.)
- A way for the governor to change the fuel to the prime mover (moving the rack or fuel valve). (The driver moves the throttle.)
- A way to stabilize the engine after a fuel change has been made.

In the example, when the car went up a hill, the driver saw the actual speed decrease and moved the throttle to increase the fuel. You will need to increase the fuel an amount to cause the speed to increase. This will give the engine enough power to make the car return to the desired speed with a bigger load. As you see that the actual speed is about to reach the desired speed, you reduce the extra fuel to the exact amount needed to match (balance) the desired speed with the actual speed. The governor does the same thing, using **feedback**. This feedback **closes the loop** in the control system which controls the amount of fuel change, based on the rate the desired speed is being reached. This prevents large overshoots or undershoots of speed which is known as **hunting**, and stabilizes the engine. The opposite is true when the car goes down the hill or load is reduced.

### 1. Speed Setting

Setting the “desired speed” of a governor is necessary to efficiently control prime movers. Modern governors have advanced systems of speed setting which can compensate for a variety of conditions when determining the desired speed. Hydro-mechanical governors use what is known as a speeder spring. The more force applied to this spring, the higher the desired speed setting is. Electronic controls use an electronic force (voltage and current) to set speed. The more the force is increased, the more the output to the fuel increases.

Speed setting and the effect on sharing loads between engines will be discussed in other chapters.

### 2. Sensing Speed

The governor must receive a force that is proportional to the speed of a prime mover. In hydro-mechanical governors, it is done by the centrifugal force of flyweights being rotated from a drive system that is connected to the prime mover, and is directly related to the speed of the prime mover. In electronic controls, this force comes from sensing of the frequency of a magnetic pickup, alternator, or generator which is directly related to the speed of the prime mover. The frequency is then changed to an electronic force that the control can use. In both cases, the faster the engine runs, the stronger the speed sensing force becomes.

### 3. Comparing the “Actual Speed” to the “Desired Speed”

The force of the “desired speed setting” and the force of the “actual speed” are compared or “summed” together. “Desired speed setting” is a force in one direction and “actual speed” is a force in the opposite direction. When these opposing forces are the same value, their sum will be zero and at that point the governor is controlling actual speed at the point of the desired speed setting. If the “desired speed setting” force is stronger than the “actual speed” force, the governor will increase fuel. If the “actual speed” force is stronger than the “desired speed setting” force, the governor will decrease fuel. As fuel is increased or decreased, these forces will change until they balance or “sum to zero.” In hydro-mechanical governors, these forces are summed at the “thrust bearing”. In electronic controls, these forces are summed at what is known as a “summing point.” Note that other forces can be applied along with these forces to allow the governor to be stabilized and perform other functions (some of these are covered in later chapters). Remember that all forces applied to the “thrust bearing” or “summing point” must algebraically sum up to zero for the governor to control fuel at a steady state.

### 4. Ways for the Governor to Change Fuel to the Prime Mover

The hydro-mechanical governor or actuator normally has a rotational or linear output shaft that is connected to the prime mover’s fuel system. When the governor needs to make a fuel correction to maintain speed (or load), the output shaft moves in the proper direction to correct the final fuel setting. For electronic controls, an electrical signal is sent to an actuator which converts this electrical signal to a mechanical force to move the fuel setting in the same way the hydro-mechanical governors do. Different types of governors and actuators have different amounts of work output to meet the control needs of various prime movers.

### 5. Ways to Stabilize the Prime Mover

Stabilization is accomplished through a variety of ways, but all of them use a “feedback” system to apply a force to the “thrust bearing” or “summing point.” This “feedback” is normally in the form of either droop or compensation, or in a combination of both. Droop or compensation is usually related to the amount the output shaft is told to move (Chapter 3 describes the essential principle of **droop** feedback).

Note that in many prime mover systems (such as power generation), the speed of the prime mover is fixed. While the governor still controls the prime mover’s speed setting mechanism, the end result of changes in the prime mover’s speed setting under fixed-speed conditions is that an increase or decrease in the speed setting causes the prime mover to take on a larger or smaller load.

## Development of the Modern Governor System

The first modern governors were applied to controlling the speed and load of water wheels (which were used to power many of the early factories during the “Industrial Revolution”. Early governors also controlled steam turbines. The development of gasoline and diesel internal combustion engines required faster and more complex governors. Electrical power generation created a much greater need for more precise governor control of speed and load.

Hydro-mechanical governors became ever more complex to meet growing needs for precise control. Since the 1970s, electronic controls have significantly improved and expanded the capabilities of governing systems, controlling not only speed and load, but also electrical loads, exhaust emissions, and many other parameters.

## Chapter 2.

# Hydro-mechanical Governors

### Basic Hydro-mechanical Governor Components

The five fundamental components of a governor were mentioned in Chapter 1. Now let's take a closer look at how the basic hydro-mechanical governor works.

The key parts of a ballhead hydro-mechanical governor are:

- Speeder Spring
- Thrust Bearing
- Flyweights
- Pilot Valve Plunger
- Pilot Valve Bushing
- Oil Pumps
- Oil Pressure Regulation
- Servo (Power) Piston
- Compensation
- Drive Shaft

### The Speeder Spring

The speeder spring is the part that sets the “desired speed”. Applying more force down on the speeder spring causes the governor to increase fuel. This initial force is usually set by the operator for the desired or “reference” speed. It can be set by a screw adjustment, a knob, a lever, an electric motor, air pressure, or solenoids, depending on the specific governor.

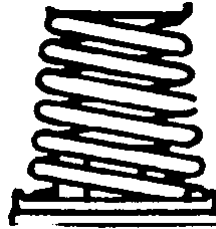

Figure 2-1. Speeder Spring

The design or shape of a speeder spring is critical to the proper operation of the ballhead.

The speeder spring is generally shaped in a conical design. This shape helps maintain a more rigid design so that it won't buckle or flex to the side as force is applied. There are other shapes of speeder springs that offer a variable force over the length.

Some springs are designed to be close to a linear operation, and some are designed to be non-linear depending on the specific governor. Most governors use the linear-type speeder spring. The PG type governor uses a non-linear speeder spring.

## Thrust Bearing

The thrust bearing is the part where the force of the speeder spring and the force of the flyweights sum together. If the speeder spring force and the flyweight force are equal, there is no load on the thrust bearing.

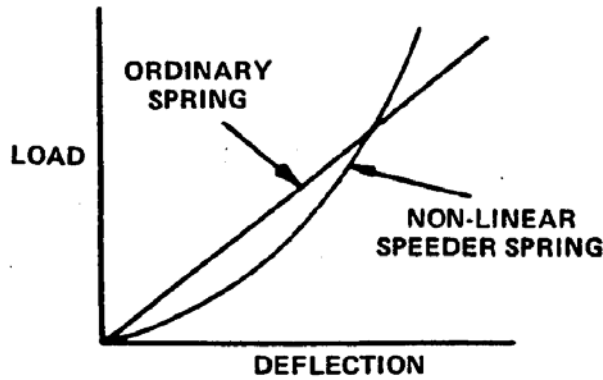
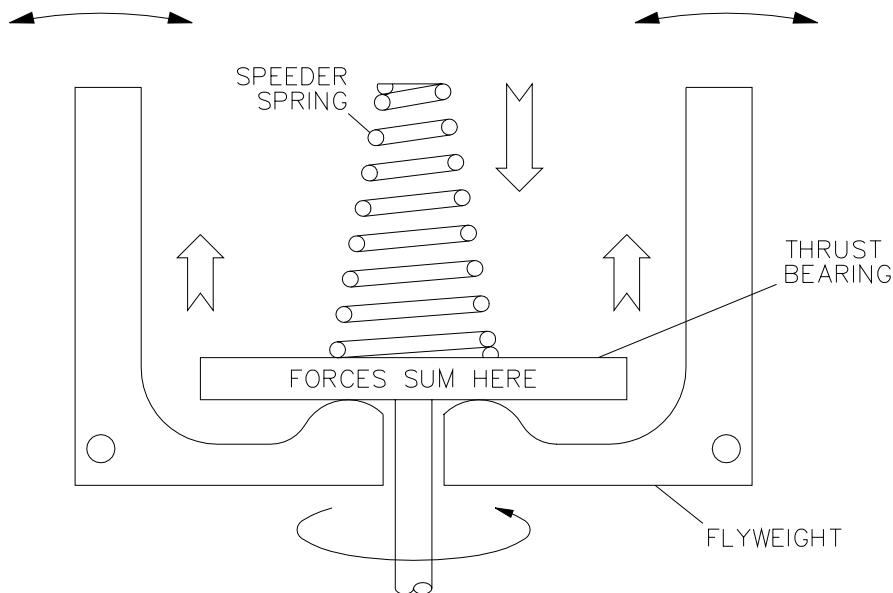

Figure 2-2. Speeder Spring Deflection

A thrust bearing has a race on the top and a race on the bottom with the bearing in between the races. Since the flyweights rotate and the speeder spring does not rotate, the thrust bearing is necessary. The pilot-valve plunger moves with the thrust bearing either directly or through a linkage. The pilot-valve plunger does not rotate.

## Flyweights

There are two flyweights in most ballheads. The flyweights are rotated by a drive from the engine that is directly related to the speed of the engine.



BALLHEAD SPEED BALANCE

825-401

Figure 2-3. Hydraulic Governor Ballhead

In Figure 2-3, the flyweights are pivoted at the lower corners. As speed increases, the flyweights move out (tip out) at the top due to the increase of centrifugal force. This causes the “toes” of the flyweights to increase the force on the thrust bearing and raise the pilot valve. The opposite effect happens when speed decreases. The flyweights move in (tip in) and reduce the force on the thrust bearing to lower the pilot valve. In Figure 2-4, the only time when the governor is run at “desired speed setting” is when the flyweights are straight up in the vertical position, closing the port in the pilot-valve bushing. If the flyweights are tipped in, the engine is running below the desired speed setting and the governor will increase fuel to increase speed until the flyweights and engine attain the desired speed setting. If the flyweights are tipped out, the engine is running faster than the desired speed setting and the governor will decrease fuel until the flyweights and engine return to the desired speed setting.

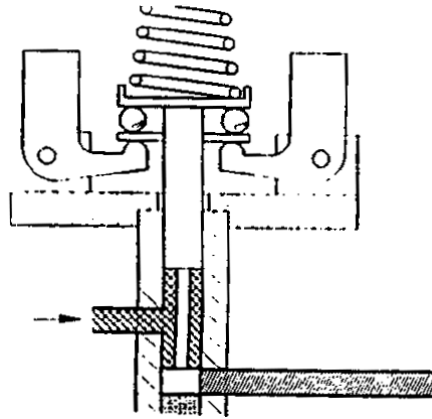

Figure 2-4. Flyweight Action

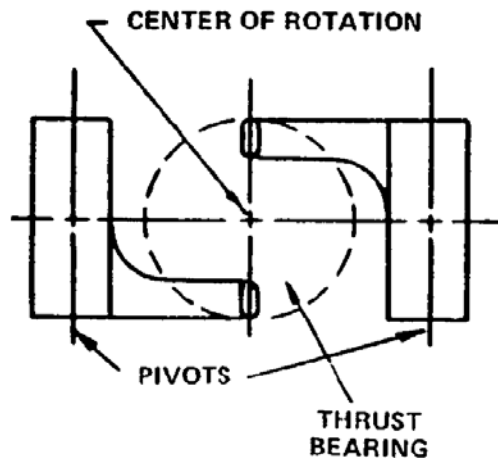

Figure 2-5. Flyweights to Minimize Friction

In the most efficient flyweight design, the toes of the flyweight are offset and contact the thrust bearing on a line at right angles to their plane of movement so that any movement is converted into a slight rotation of the thrust bearing with a minimum amount of sliding friction. There are other designs of flyweights.

Friction in governors is also reduced by the use of low-friction bearings. The reduction of friction reduces the deadband between speed change and governor output change.

## Pilot Valve Plunger and Bushing

The pilot-valve plunger is positioned by the force on the thrust bearing. It moves up and down inside the rotating pilot-valve bushing (due to the flyweights sensing speed changes and tipping in or out). The pilot-valve bushing has high pressure oil coming from the oil pump into the bushing above the control land of the pilot-valve plunger.

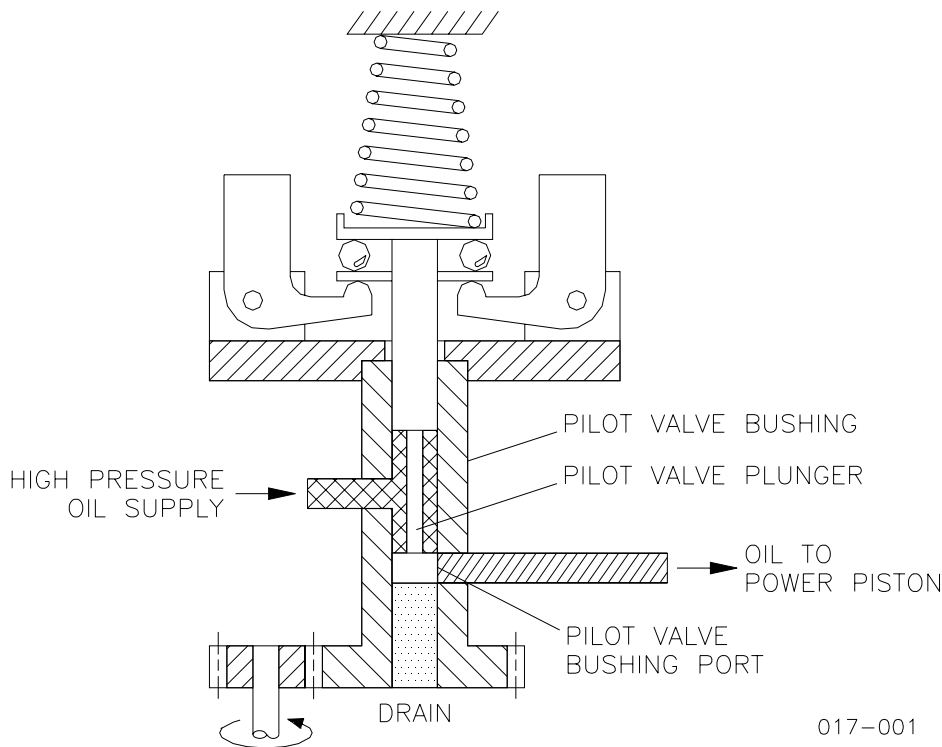

Figure 2-6. Pilot Valve Operation Shown “On Speed”

The pilot-valve bushing has ports in it to allow the flow of oil to or from the power cylinder assembly. When the governor and engine are at the desired speed setting, the pilot-valve-plunger control land is centered over the port in the pilot-valve bushing. This stops oil from flowing to or from the power cylinder assembly.

If the flyweights tip in, due to a change in speed or load, the pilot-valve plunger moves down and let high-pressure oil into the power-cylinder assembly. This will increase fuel.

If the flyweights tip out, due to a change in speed or load, the pilot-valve plunger moves up to let oil drain from the power-cylinder assembly. This will decrease fuel.

Pilot-valve-bushing ports have different sizes and shapes for different types of governors to allow more or less oil flow, depending on the application.

The pilot-valve bushing rotates and the pilot-valve plunger does not. This minimizes static friction (called sticktion) and allows the pilot-valve plunger to move with very slight speed changes.

## Oil Pumps

Most hydro-mechanical governors and actuators use the governor drive to rotate a hydraulic pump which provides the pressure oil for the system controlled by the pilot valve. Woodward uses two different types of pumps. Most governors use the two- or three-gear positive displacement pump. The 3161 and TG governors and some actuators use an internal gear oil pump.

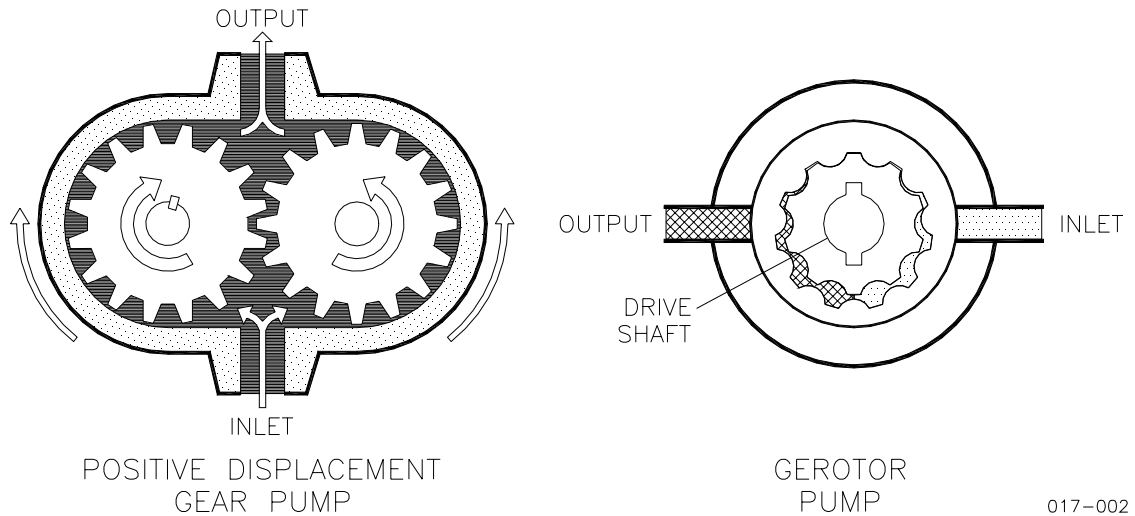

017-002

Figure 2-7. Oil Pumps

The constant-displacement pump has one drive gear and one or two idler gears that rotate in a gear pocket. As the gears turn, oil is drawn from the oil supply and carried in the space between the gear teeth and the walls of the gear pocket to the discharge side of the pump. The oil is forced from the space around the gear teeth as the drive and idler gears are rotated and becomes pressurized.

The hydraulic circuits connected to the pumps can be designed to allow either one direction of rotation or reversible rotation for use on diesel engines with drives that run in both directions. Check valves are used to provide pump rotation in either direction. Plugs allow pump rotation in only one direction. Internal gear pumps allow rotation in only one direction. The pump must be removed from the governor and rotated 180° to change direction of rotation for internal gear pumps.

The pumps are designed to provide more pressure and flow than needed within the governor. The extra flow of oil is returned to sump. Smaller governors use a relief valve. Most larger governors use an accumulator system which provides a spring-compressed reservoir of pressure oil for use during transits which temporarily exceed the output of the pump. SG, PSG, and EGB-2 governors use relief valves. A number of hydraulic actuators do not have accumulators.

The relief valve shown in Figure 2-8 is typical of the valves used in SG, PSG, EGB-2 governors and many hydraulic actuators.

Internal operating oil pressures are specified for each governor. Typical pressures are 100 to 500 psi (690 to 3448 kPa). Different types of governors operate at different pressures. Check the specifications for your governor's pressure. The higher pressures are created to get more output power from the servo controlled by the governor. Higher pressures may require the addition of special heat exchangers to avoid damage to (break down of) the oil being used in the governor.

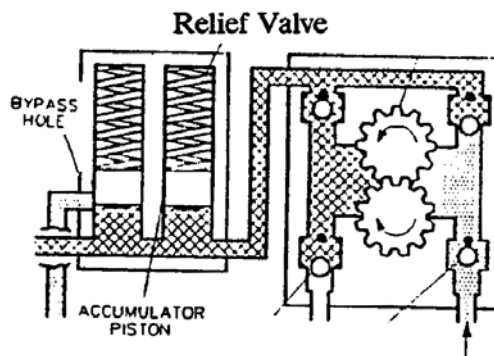
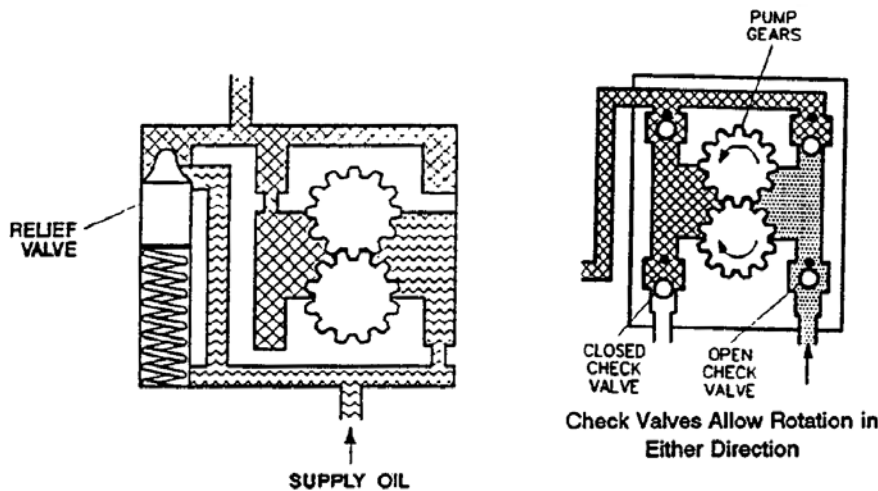
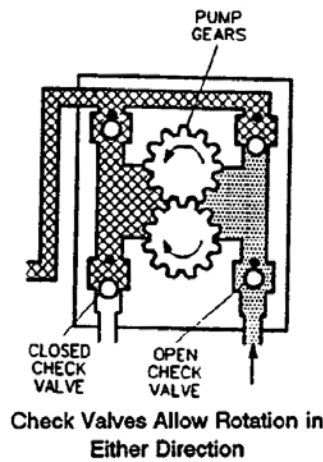
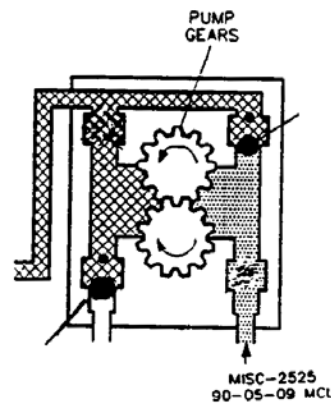

Figure 2-8. Accumulator and Governor Relief Valve



Check Valves Allow Rotation in Either Direction



Plugs Allow Rotation in One Direction Only

Figure 2-9. Pump Rotation

Accumulator function is shown in Figure 2-8. Pressurized oil on the discharge side of the pump first fills the various oil passages and then forces the accumulator pistons up against the downward force of the accumulator springs. When the pressure increases enough to move the piston up to uncover the bypass hole, the excess oil from the governor pump returns to sump. The accumulators thus not only provide a reservoir for pressure oil, but also act as a relief valve to limit maximum pressure in the hydraulic circuit. The accumulators shown are from the power case type of governor (PG and larger EGB governors). UG and 3161 governors use different styles of accumulators, although the function is similar.

### Direction of Rotation

The arrangement of the four check valves on the suction and discharge sides of the oil pump permits the governor drive shaft to be rotated in either direction, without any changes being made in or to the governor. The direction of pump rotation does not affect the oil pressure system or governor operation.



Some governor models are built without check valves. In these units, two plugs replace the two closed check valves, and the governor must always be rotated in one direction only. To change direction of rotation in these governors, the location of the plugs must be changed by removing the base.

The internal gear pump rotates in one direction only. To change direction of rotation in an internal gear pump, the pump is rotated 180°.

If the plugs or internal gear pump are set up for the wrong direction of pump rotation, the governor will not have any oil pressure and cannot control the engine. This can also cause damage to the governor. Drive rotation is always shown looking down on the governor.

## The Servo (Power) Piston

The governor pilot valve plunger controls the movement of the power piston. The power piston, acting through the connecting linkage, controls the engine fuel.

Two types of power pistons are used in governors:

- A spring loaded system where oil pressure is used to increase the output position. When pressure oil under the power piston is directed to sump a return spring (either pushing directly on the piston or connected to linkage from the piston) causes the position to move toward minimum fuel.
- A Differential Power/Servo piston uses pressure oil to move it in both directions.

### Spring-Loaded Power/Servo Piston

The governor pilot valve plunger controls the movement of the power piston. The power piston, acting through the connecting linkage, controls the engine fuel.

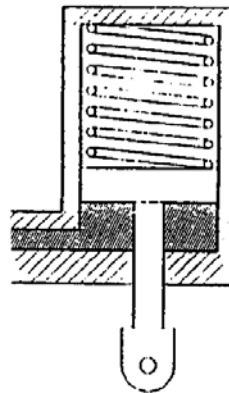

Figure 2-10. Spring Loaded Servo Piston

The return spring continually pushes the power piston down in the “decrease fuel” direction. However, the power piston will not move down unless the pilot-valve plunger is raised above its centered position. Only when the pilot-valve plunger is above center can the oil trapped in the circuit between the plunger and power piston escape to sump. If the pilot valve plunger is lowered, pressure oil from the governor pump will be directed to the power piston and will push the piston up, against the force of the power spring, in the direction of increase fuel.

Note that the power piston will move only when the pilot-valve plunger is not centered, permitting the oil flow required. With the plunger centered, the power piston is, in effect, hydraulically locked.

The output of the power piston can be a push-pull motion or converted to a rotary motion. It is designed to move the fuel to the minimum position should the oil pressure fail.

### Differential Power/Servo Piston

The governor pilot-valve plunger controls the movement of the power piston. The power piston, acting through the connecting linkage, controls the engine fuel.

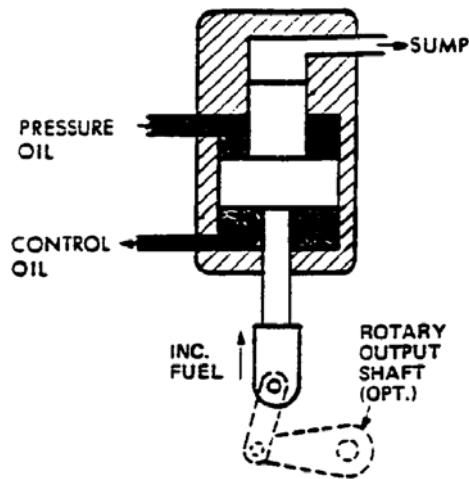

Figure 2-11. Differential Power Piston

The power piston requires pressure oil to move in either the increase or decrease fuel direction. A differential type piston has more area on one side of the piston than on the other. Pressure oil is constantly directed to the side with the smaller area. This constant pressure pushes the piston in the decrease fuel direction. The piston can only move to decrease fuel when the pilot valve is raised above center, allowing oil to drain to sump.

If the pilot-valve plunger is below its centered position, control oil flows to the bottom side of the power piston with the larger area. (Pressure oil is always against the top side with the smaller area.) The pressures on both sides of the piston are about the same, the surface area is greater on the bottom side (control oil). This gives it a larger force and moves the piston in the increase fuel direction.

Note that the power piston can move only when the pilot-valve plunger is uncentered to permit the oil flow required. With the plunger centered, the power piston is hydraulically locked.

Two different hydraulic circuits are used for the oil passages between the pilot valve plunger control land and the power piston. The scheme used in a particular model depends upon the size of the power piston.

The output of the power piston can be a push-pull motion or a rotary motion. Oil stored in the governor accumulator is sufficient to move the power piston to minimum fuel in case of governor failure.

## Chapter 3.

# Droop

### Introduction

Droop has many uses and applications in the control of engines. Without some form of droop, engine-speed control would be unstable in most cases.

***Droop is defined as a decrease in speed setting at the load increases.***

Droop is expressed as a percentage of the original speed setting from no load to full load. The normal recommended percent of droop is 3% to 5%. A minimum of 2.5% is required to maintain stability in a speed-droop governor.

Droop is calculated with the following formula:

$$\% \text{ Droop} = \frac{\text{No Load Speed} - \text{Full Load Rated Speed}}{\text{Full Load Rated Speed}} \times 100$$

If, instead of a decrease in speed setting an increase takes place, the governor is showing negative droop. Negative droop will cause instability in a governor.

Simple hydro-mechanical governors have the droop function built in and always operate in droop. More complex governors include temporary droop, which returns the speed setting to its original speed setting after the engine has recovered from a change in speed or load. The temporary droop is called "compensation."

### Why Is Droop Necessary?

In a system without droop, a load increase will cause the engine to slow down. The governor will respond by increasing the fuel until the engine speed has returned to the original speed.

Due to the combined properties of inertia and power lag, the engine speed will continue to increase beyond the original speed setting, causing an overshoot in speed. The governor again will respond to decrease speed to correct for the overshoot. It will over-correct the speed in the other direction causing an undershoot. This overcorrection of speed in both directions (instability) will amplify until the engine trips out on overspeed.

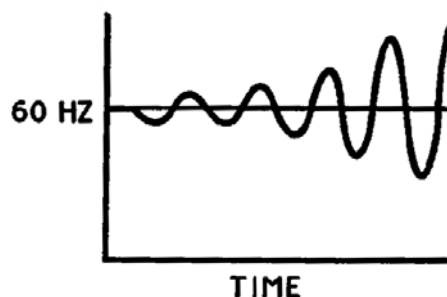

Figure 3-1. Response Curves of Governor without Droop or Compensation

This instability problem can be eliminated with droop. As the load increases, the speed setting is decreased. When the governor moves to correct for the speed decrease caused by the increased load, it will be correcting to a lower speed setting. This lower speed setting prevents the speed from overshooting.

## Speed Droop Operation

### Simple Speed Droop Governor

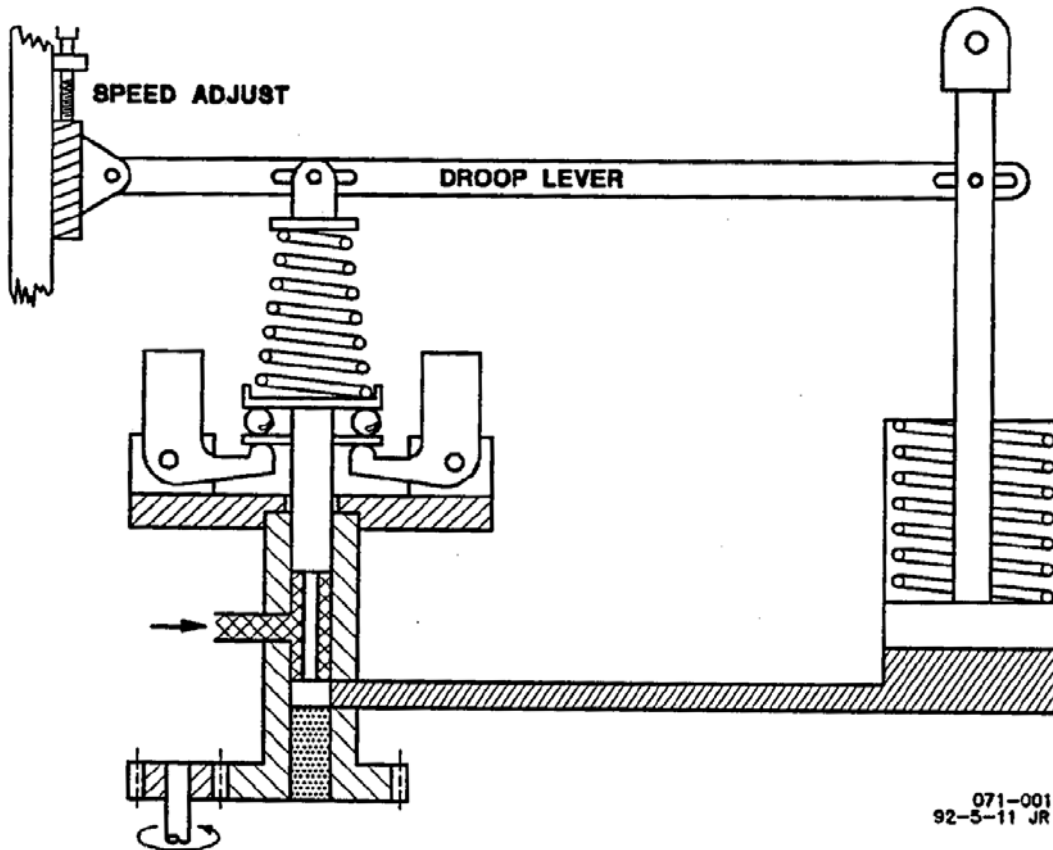

Figure 3-2. Droop Feedback

As load is applied to the engine, the power piston moves up to increase fuel. The droop feedback lever is connected to the power piston and speeder spring. The feedback lever pulls up on the speeder spring to reduce its force. With less force on the speeder spring, the speed setting is decreased, causing the droop action which maintains the load at a lower speed.

### Compensated Governors

For compensated governors, when a load is applied, the temporary force of the compensation system pushes up on the pilot valve compensation land. This force adds to the force of the flyweights to close the pilot valve before the engine speed is reached. This temporary force addition works in the same way as if the speed setting had been reduced. The force through the needle valve of the compensation system is reduced to zero as the engine returns to speed. This is known as “temporary droop”.

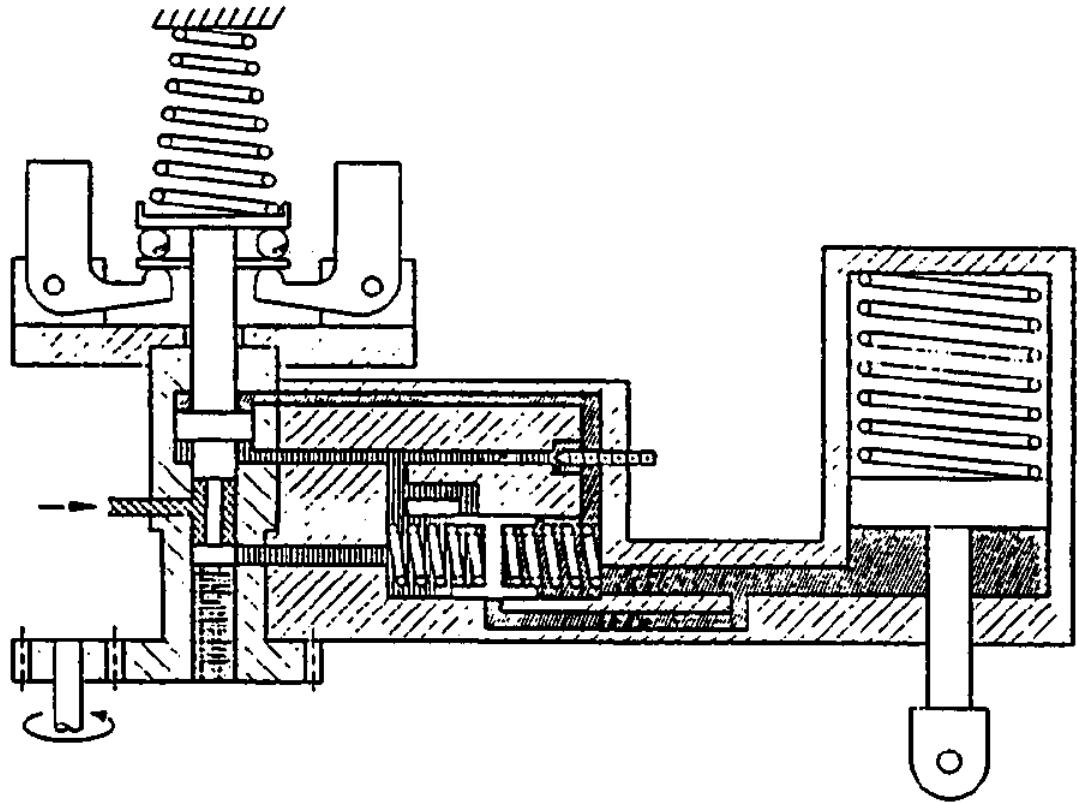

Figure 3-3. Compensated Governor Schematic

### The Droop Curve

Droop is a straight line function, with a certain speed reference for every fuel position. Normally a droop governor lowers the speed reference from 3% to 5% of the reference, from no load to full load. Thus, a 3% droop governor with a reference speed of 1236 rpm at no load would have a reference speed of 1200 rpm at full load.

If the linkage is changed, altering the amount of governor output shaft travel from no load to full load, the droop must be reset. Be sure to use a least 2/3 of the governor output shaft travel to ensure stability and allow sufficient droop range adjustment.

### Uses Of Droop

#### Isolated Unit

Most governors are capable of operating in the isochronous mode, However, droop operation is necessary for many applications.

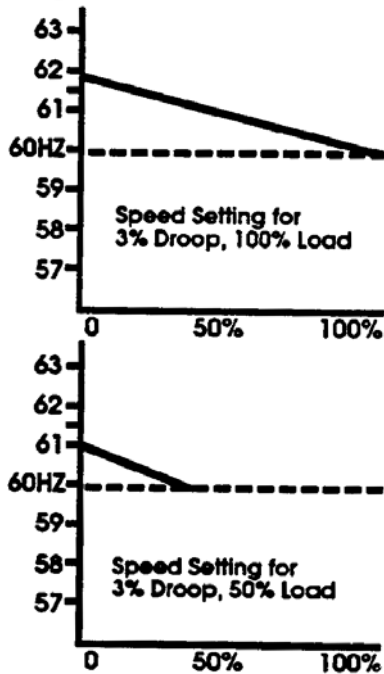

Figure 3-4. Comparison of 3% Droop Speed Settings for 50% and 100% Load

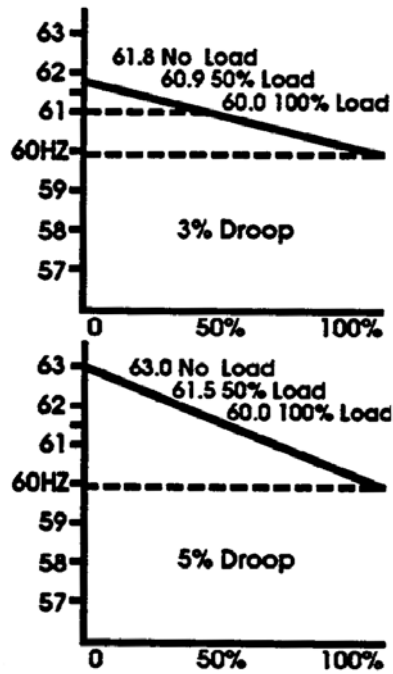

Figure 3-5. 3% and 5% Droop Curves

Isolated, single-engine applications can operate in either isochronous or droop. In single engine applications, the engine operation is not affected by any other engines or the utility. In isochronous operation, the speed returns back to the original speed after a load has been applied up to 100% load. In droop operation, the speed decreases by a set percentage after a load has been applied. In the droop mode, if the original speed is desired, the operator must raise the speed setting to return to the original speed when a load is applied.

## Isolated Systems

An isolated system is an application where two or more engines are driving a common load. This load could be electrical generators, pumps, ship propellers, or combinations of these and any other mechanical loads. These isolated systems are not connected to any other systems or to a utility.

Without some form of isochronous load sharing scheme like the electronic isochronous load sharing control, droop must be used to share these loads.

The isochronous mode can also be used on one engine, running in parallel with any other engine. However, unless the governors have isochronous load sharing capabilities, no more than one of the engines running in parallel can be in the isochronous mode. If two engines operating in the isochronous mode without load sharing controls are supplying power to the same load, one of the units will try to carry the entire load and the other will shed all of its load. In order for the two units to share load, some additional means must be used to keep each engine from either trying to take all the load, or from motoring.

The reason for one unit taking all the load and the other unit dropping all the load is shown in the following example:

If two isochronous units are to be coupled together on the same load and the speed settings are not the same, the system will become unbalanced when coupled together. Since there cannot be two different speeds on one system coupled together, one engine will have to decrease its actual speed and the other will have to increase its actual speed to an average speed between the two. The governor on the engine that decreased speed will move to increase fuel to try to correct for the decrease in speed, and the governor on the other unit that increased speed will move to decrease fuel to try to correct for the increase in speed. The result will be that the engine with the higher speed setting will continue to take all of the load until it reaches its power limit, and the other engine will shed all of its load and become motored (driven by the other engine).

As seen by the example, units running in isochronous cannot share loads without an isochronous load sharing scheme.

### Using Droop to Share Loads

If all engines in a droop system have the same droop setting, they will each share load proportionally. The amount of load each carries will depend on their speed settings. If the system load changes, the system speed/frequency will also change. A change in the speed setting will then be required to offset the effect of droop and return the system to its original speed/frequency. In order for each engine in the system to maintain its proportion of the shared load, the operator will need to adjust the speed setpoint equally for each engine.

If all engines in a droop system do not have the same droop setting, they will not share loads proportionally with the same speed settings. If the system load changes, the system speed/frequency will also change but the percent of load on each engine-generator set will not be changed proportionately.

The operator will need to adjust the speed setpoint differently for each engine to make them carry their proportional share of the load. This could result in running out of speed setpoint adjustment on an engine before it is fully loaded and limiting the system load sharing capability. It is best to have the same percent of droop set on each engine (3% to 5% is recommended).

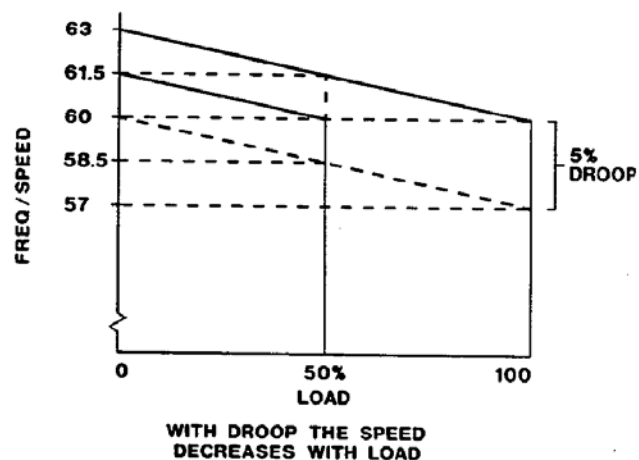
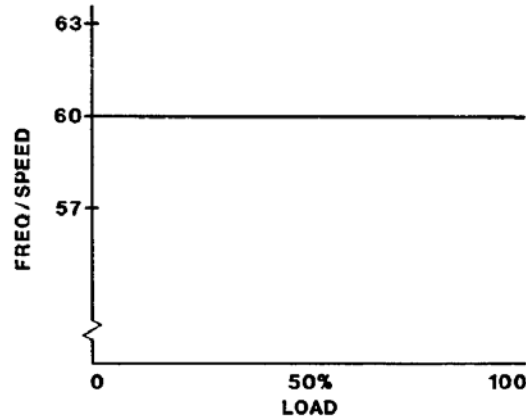

Figure 3-6. Droop Mode

## Isolated Systems

### Droop/Isochronous

Droop/Isochronous combines the first two modes. All engines in the system are operated in the droop mode except for one which is operated in the isochronous mode. It is known as the swing machine. In this mode, the droop machines will run at the speed/frequency of the isochronous unit. The droop percentage and speed settings of each droop unit are adjusted so that it generates a set amount of power. The output power of the swing machine will change to follow variations in the load demand while maintaining constant speed/frequency of the system (see Figures 3-3 and 3-4).



**Isochronous unit maintains frequency  
and takes load swings**

Figure 3-7. Swing Machine

Maximum load for this type of system is limited to the combined output of the swing machine and the total set power output of the droop machines. A load above this maximum will result in a decrease in speed/frequency. The minimum system load cannot be allowed to decrease below the combined output set for the droop machines. If it does, the system frequency will increase and the swing machine can be motorized.

The machine with the highest output capacity should normally be operated as the swing machine so that the system will accept the largest load changes within its capability. This is not a rigid rule. Selection of the swing machine will depend on such things as efficiency of different engines and the amount the load is expected to change.



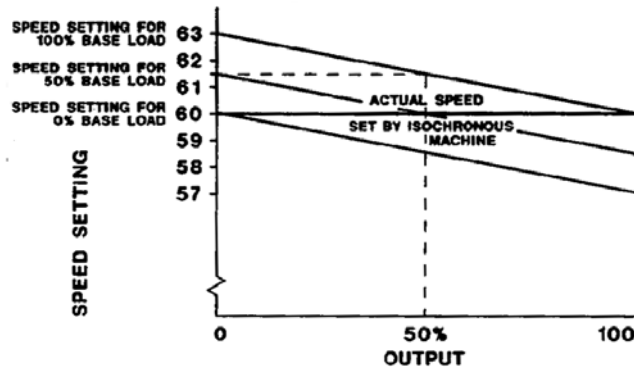

**Droop unit(s) maintains a set load.**

Figure 3-8. Droop Units

### System Tied to a Utility Grid

Previously the use of droop has been discussed for systems that were isolated (not tied to another larger system such as a utility). When an engine-generator set is paralleled with a utility, there are a few things to consider:

- The utility will basically act as an isochronous unit. The utility will set the speed/frequency for any units being paralleled to it. A simple isochronous unit cannot be paralleled to the utility.
- When an isochronous engine-generator set is connected to a utility bus, the utility will determine the speed/frequency of the generator. Should the governor speed reference be less than the utility frequency, power in the utility bus will flow to the generator and motor the unit. If the governor speed is even fractionally higher than the frequency of the utility, the governor will go to full load in an attempt to increase the bus speed. Since the definition of a utility is a frequency which is too strong to influence, the engine will remain at full load.

Droop provides the solution to this problem. Droop causes the governor speed reference to decrease as load increases. This allows the governor to vary the load with the speed setting since the speed cannot change.

### Droop Base Load

Droop base load is the same as droop, with the exception that the utility or grid will control the frequency and act as does the swing machine, absorbing any change in load. The speed and droop settings are adjusted so that the engine-generator set supplies a fixed, or base amount, of power to the utility (see Figure 3-7).

Based on 5% droop, increasing the speed setting to 61.5 Hz will produce 50% power output. Following the droop line from the 61.5 Hz setting to the point where it crosses the 60 Hz line (controlled by the utility) it can be seen that the engine-generator set is at 50% power output. If the speed setting is increased to 63 Hz, the power output will be at 100%. Where the droop line crosses the utility frequency line is the amount of power output produced. If the utility frequency varies, the amount of output power will vary inversely. If the utility frequency increases, the droop line will cross the higher utility frequency line closer to zero power and produce a lower output or power. If the utility frequency decreases, the droop will cross the lower utility frequency line farther from zero, producing a higher output power. This condition is often mistaken for a governor problem, which it is not.

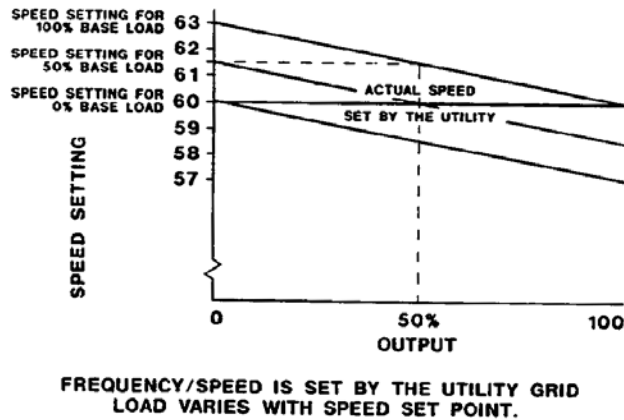
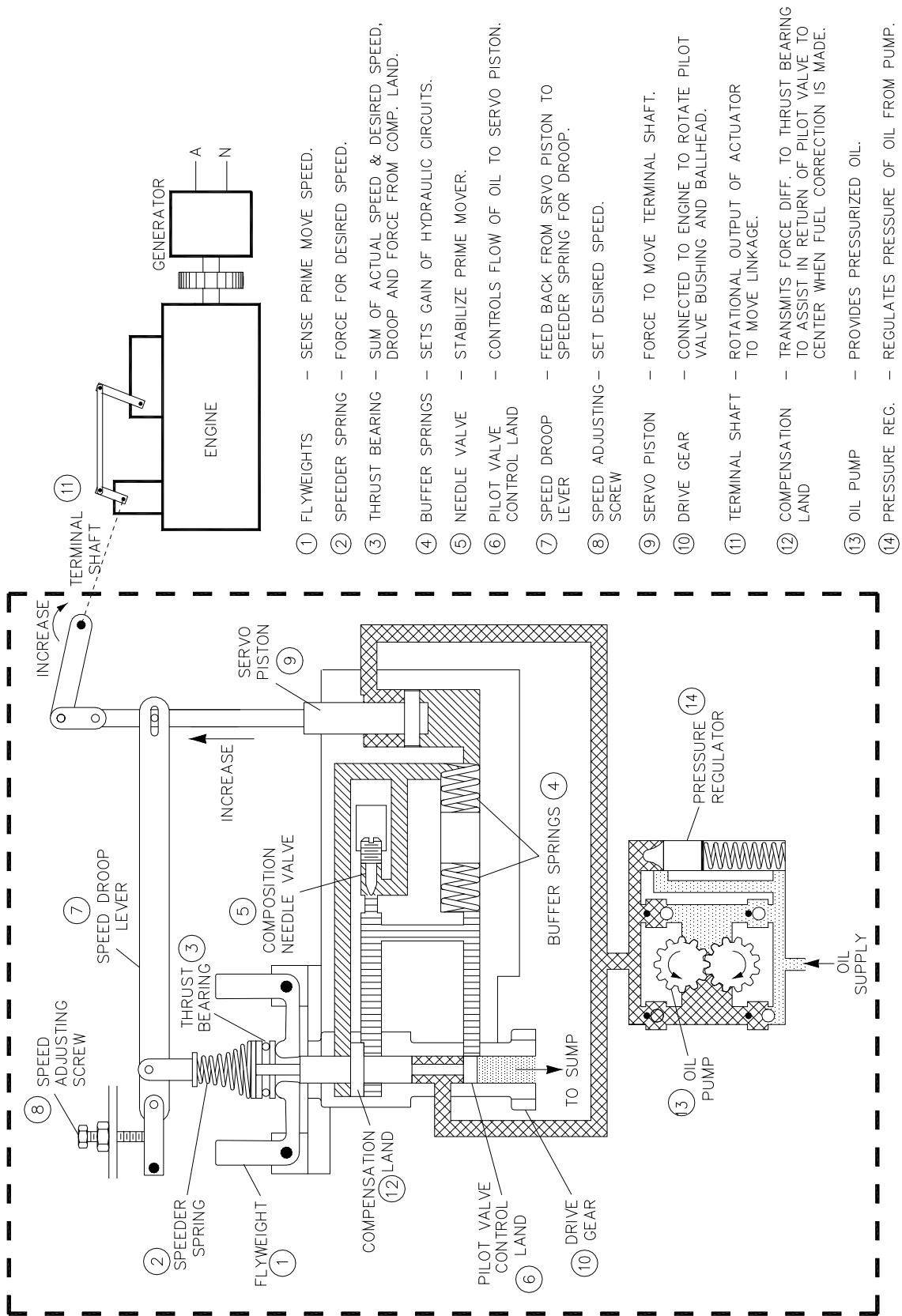

Figure 3-9. Base Load with 5% Droop

If the engine-generator set is to be unloaded and disconnected from the utility, simply decrease the speed setting slowly until the engine generator set is at minimum power output, then open the tie breaker.

If the engine generator set is running in a loaded condition and the tie breaker opens, separating the engine generator set from the utility, the frequency will increase to the speed setting point. The amount the frequency increases depends on where the speed setting was when the tie breaker opened.



TU--265  
91-05-14 MCL

Figure 3-10. Schematic of Droop Governor

# Chapter 4. Linkage

## General

Linkage between the governor output and the engine fuel control system is responsible for many unacceptable control conditions that appear to be governor connected. When acceptable governor control deteriorates or changes, linkage is one of the first areas to troubleshoot. Loose or worn linkage not only can cause unacceptable governor control, but it can also present dangerous conditions should it fail completely and leave the engine uncontrolled. **Good locking methods must be used at all linkage connections.**

There must be no lost motion or binding in the linkage attached between the governor and the engine. Binding or “catches” in the linkage can cause speed excursions and other problems which may appear as being caused by the governor. Lost motion in the linkage will cause the governor to have to travel the distance of the lost motion before any fuel change is made. The governor will become over-active in fuel control. This overly active governor will provide less than optimum control. An overactive governor will also cause excessive wear in linkage and in the governor. The engine will tend to move up and down in speed or wander.

Governor operation is based on the assumption that linkage is so arranged that a given movement in the governor output will provide a proportional change in the fuel to the engine.

Many fuel control systems provide a nearly linear response in engine output. (This is usually true of diesel engines.) Other fuel control systems provide a non-linear response to change in the control device position and engine outputs. (This is particularly true of carbureted engines with butterfly valves.) All governors tend to provide nearly linear travel. Differences between the linearity of governor travel and the linearity in the engine fuel control system or valve are accomplished by the design of the linkage between the governor and the engine fuel system or valve.

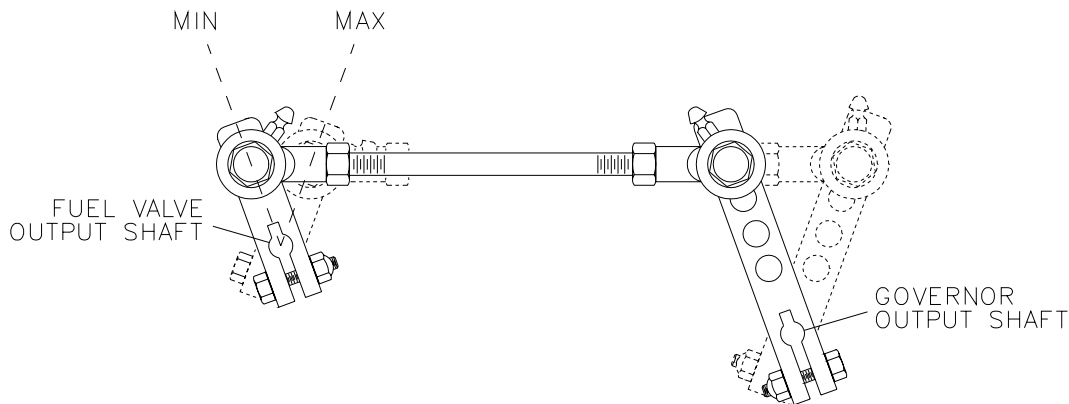

USED ON:  
● DIESELS, GAS TURBINES AND FUEL INJECTED ENGINES

250-073  
02-7-31

Figure 4-1. Linear Fuel Control

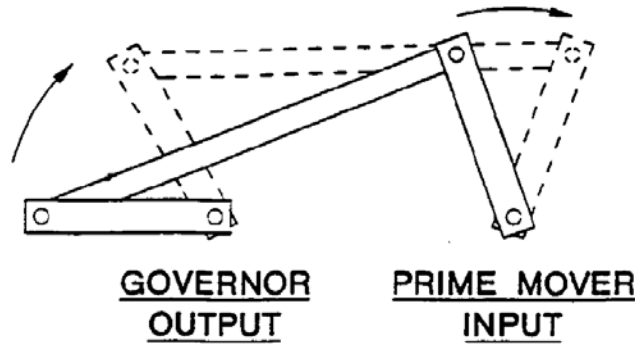
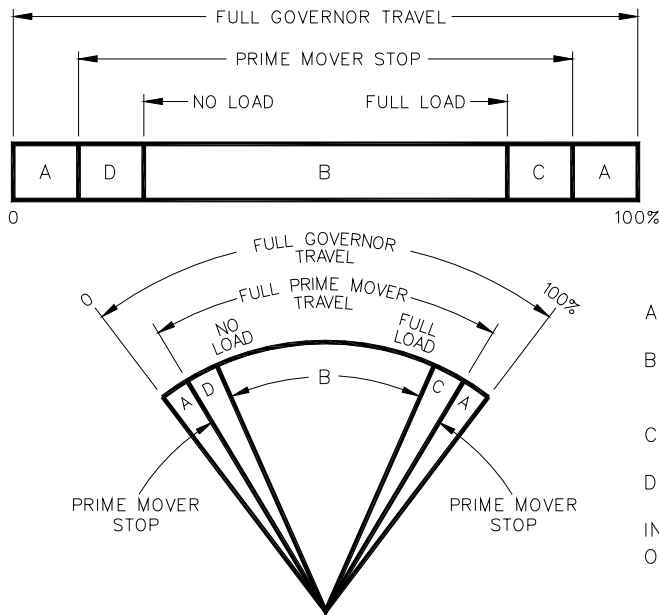

Figure 4-2. Non-Linear Fuel Control

### Governor Travel

Design of the fuel linkage must provide for control of fuel from “FUEL OFF” to “FULL FUEL” within the limits of the travel of the governor output shaft. The design must also provide for about 2/3 output shaft travel between “NO LOAD” and “FULL LOAD.” If less than 2/3 travel from no load to full load is not used, it may not be possible to stabilize the engine. If a lot more than 2/3 travel from no load to full load is used, there may not be enough travel to be sure the fuel is shut off at minimum governor travel, and full fuel may not be reached at maximum governor travel. This can make the engine appear sluggish. In both cases, the misadjusted linkage can appear as a governor problem when it really is not a governor problem.



- A – OVERTRAVEL TO ENSURE PRIME MOVER STOPS ARE REACHED
  - B – NO LOAD TO FULL LOAD TRAVEL – NORMALLY 2/3 OF FULL GOVERNOR TRAVEL IS RECOMMENDED
  - C – TRAVEL REQUIRED TO ACCELERATE THE PRIME MOVER
  - D – TRAVEL REQUIRED TO ACCELERATE OR SHUT DOWN PRIME MOVER
- IN SPECIAL APPLICATIONS MIN AND MAX PRIME MOVER STOPS MAY BE OUTSIDE THE GOVERNOR STOPS.

MISC-1497  
89-3-22

Figure 4-3. Correct Use of Governor Travel

## Linear Linkage Arrangements



This Linkage design provides a large amount of engine fuel motion for a small amount of governor motion.

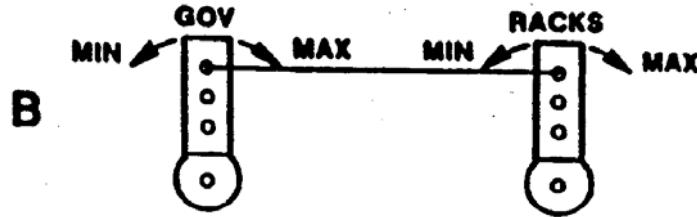

This Linkage design provides equal amounts of engine fuel motion and governor motion.

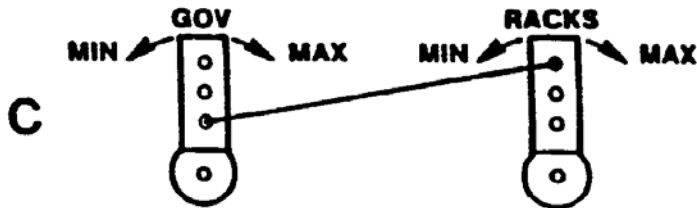

This Linkage design provides a large amount of governor motion for a small amount of engine fuel motion.

A linear linkage arrangement is used in applications where the governor output shaft positioning is directly proportional to the torque output of the engine. A linear linkage is a linkage design which provides as much movement of the governor output shaft per increment of engine fuel movement at light loads as at heavy loads.

Using less than the recommended amount of governor travel will provide governor control which exhibits fast response and is, or tends to be, unstable. Droop load sharing could be impossible if too little governor output shaft travel is being used.

Using a lot more than 2/3 of the governor travel may not let the fuel system be shut off or may not let the fuel system be opened to maximum.

The linkage must be set up to shut fuel completely off and let fuel be opened to full fuel. Use at least 2/3 of the full governor travel from zero load to 100% load.

## Non-Linear Usage

Butterfly carburetor valves present extremely non-linear control characteristics. At minimum positions (light load), the valve must move very little to change the amount of fuel flow a large amount. At higher loads, the valve must move a large amount to have any effect on fuel flow. Since governor output travel is essentially linear, special linkage is necessary to make the two conditions compatible. This is called “non-linear linkage.” Non-linear linkage is also required on some diesel injection systems, although these conditions are not usually as severe as they are when controlling a butterfly carburetor valve. In all cases the linkage should be designed to provide increased engine output in direct proportion to movement of the governor output.

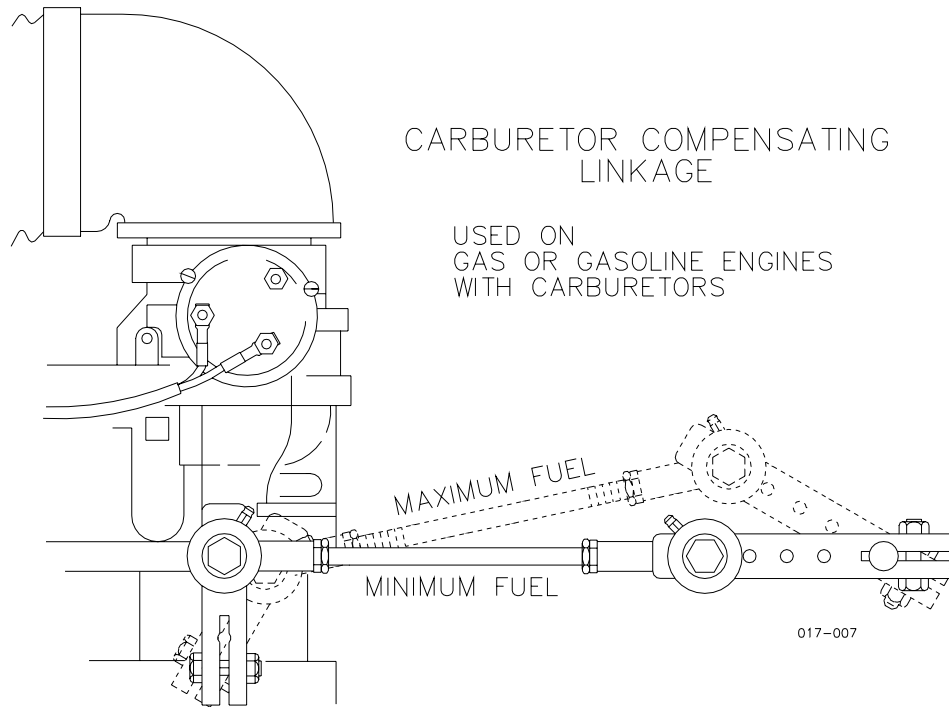

Figure 4-4. Nonlinear Carburetor Linkage

When installing this linkage, make sure the following conditions are obtained when the governor output is in the min fuel position:

- The governor lever and connection link are in line with the governor output shaft and the point of attachment on the connecting link to the butterfly carburetor lever.
- The butterfly carburetor lever is 90° with the connecting link.

## Chapter 5. Magnetic Pickups

### Introduction

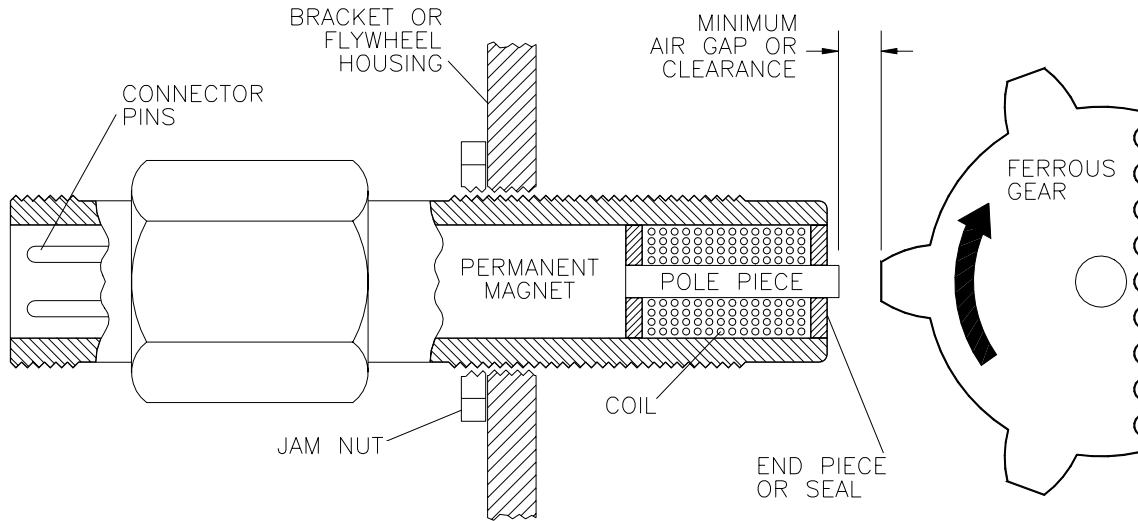

OUTPUT FREQUENCY OF MAGNETIC PICKUP IN HERTZ

$$\text{Hz} = \frac{\text{NO. OF GEAR TEETH} \times \text{GEAR RPM}}{60}$$

EN-0122  
97-04-23

Figure 5-1. Magnetic Pickup

A magnetic pickup (see Figure 5-1) is the device most often used to sense the speed of a prime mover. It is basically a single pole, alternating current, electric generator consisting of a single magnet with a multiple-layer coil of copper wire wrapped around one pole piece. The field or flux lines of the magnet exit the north pole piece of the magnet, travel through the pole piece and air path to surround the coil, returning to the south pole of the magnet. When a ferrous material, such as a gear tooth, comes close enough to the pole piece (see Figure 5-2) the reluctance path is decreased and the flux lines increase. When the ferrous material is far enough away from the pole piece (see Figure 5-3), the original air path is re-established, and the flux lines will decrease to the original level. This increase and decrease of flux induces an ac voltage into the coil around the magnet.



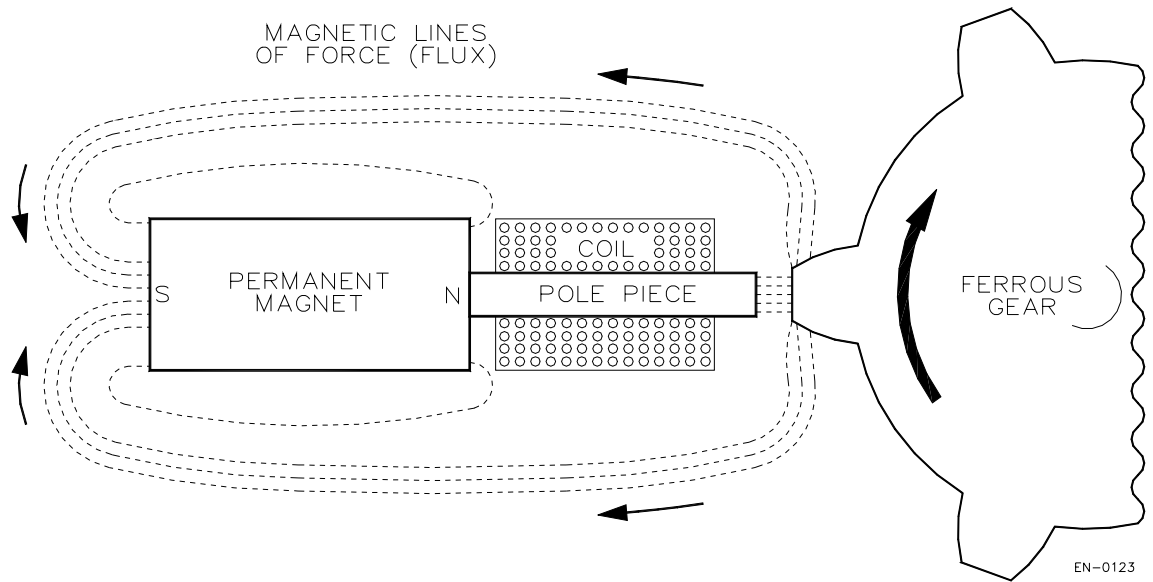

Figure 5-2. Low Reluctance Gear Position

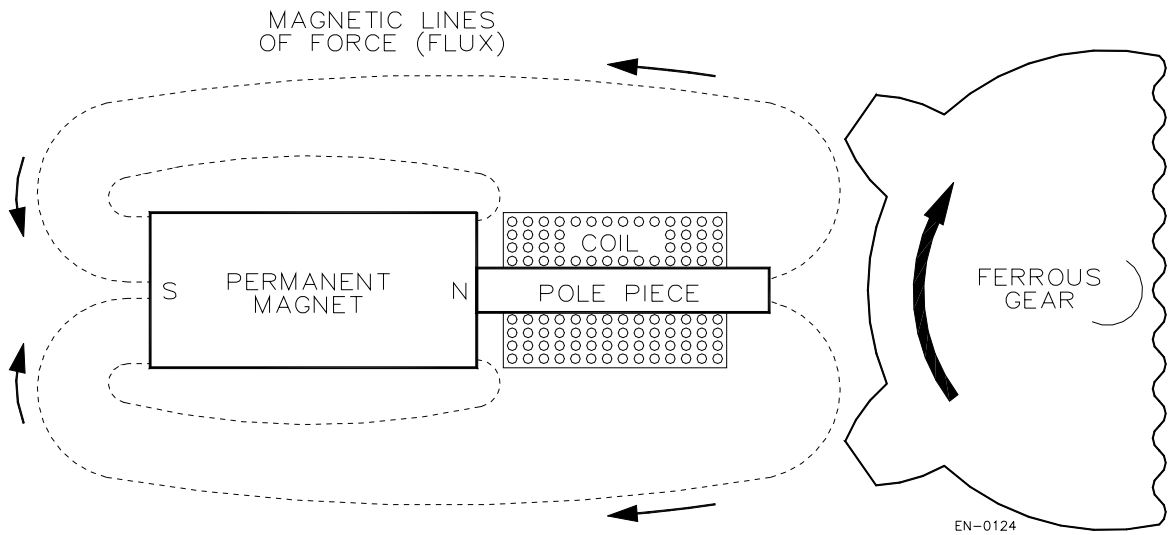
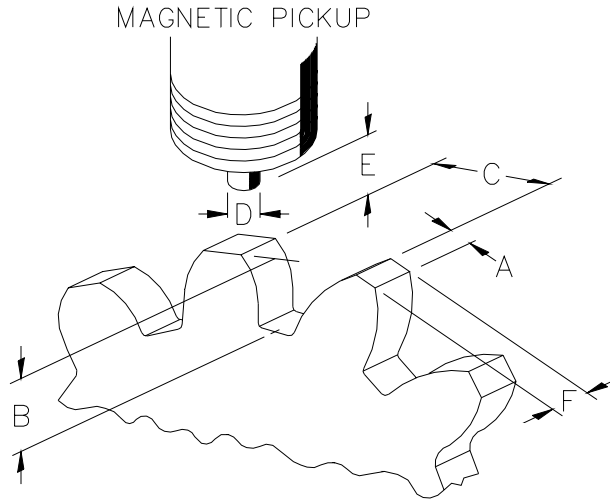

Figure 5-3. High Reluctance Gear Position

The output of this single pole generator, known as a magnetic pickup (MPU), depends on the surface speed of the gear being monitored, the gap or clearance between the pole piece and the gear teeth, the dimensions of the magnetic pickup and those of the gear (see Figure 5-4), and the impedance connected across the output coil of the magnetic pickup. The voltage wave form of the output depends on the shape and size of the gear teeth relative to the shape and size of the end of the pole piece (see Figure 12-5). Any change in the reluctance of the flux path, external to the magnetic pickup, caused by the addition or removal of ferrous material will cause an output voltage to be developed. Gear teeth, projections, or holes, can be used to change the reluctance. Spacing between the gear teeth, projections, or holes must be uniform. Differences in spacing will be seen as changes in frequency or speed.

- A = DIMENSION OF TOP OF TOOTH
- B = HEIGHT OF TOOTH
- C = SPACE BETWEEN TEETH
- D = DIAMETER OF POLE PIECE
- E = CLEARANCE (GAP)
- F = GEAR THICKNESS



THE OPTIMUM RELATIONSHIP FOR MAXIMUM OUTPUT IS AS FOLLOWS:

- (A) EQUAL TO OR GREATER THAN (D)
- (B) EQUAL TO OR GREATER THAN (C)
- (C) EQUAL TO OR GREATER THAN THREE TIMES (D)
- (D) EQUAL TO OR GREATER THAN (D)

EN-0125  
92-1-30 GA

Figure 5-4. Magnetic Pickup and Gear Dimensions

Additional information can be found in manual 82510, *Magnetic Pickups and Proximity Switches for Electronic Controls*.

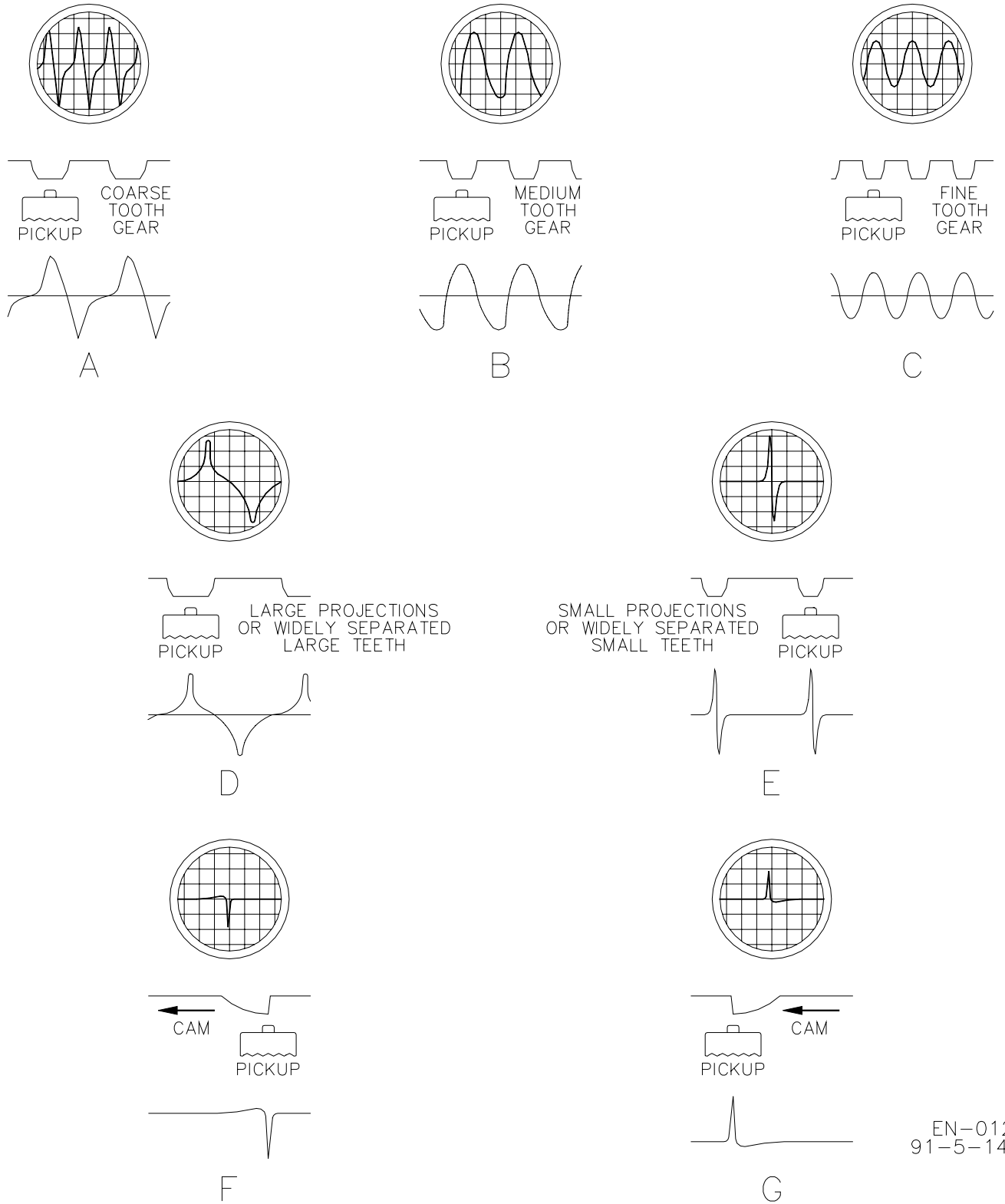

EN-0126  
91-5-14 GA

Figure 5-5. Generated Waveforms

## Chapter 6. Load Sensing, Load Sharing, Base Loading

### Load Sensing

The generator load sensor senses the load on a generator. To sense this load, current transformers (CTs) are placed around the power output leads coming from the generator. As load is applied to the generator, alternating current flows through the generator lines and induces current into the CTs. The current in the CTs increases proportionally with the load on the generator (see Figure 6-1).

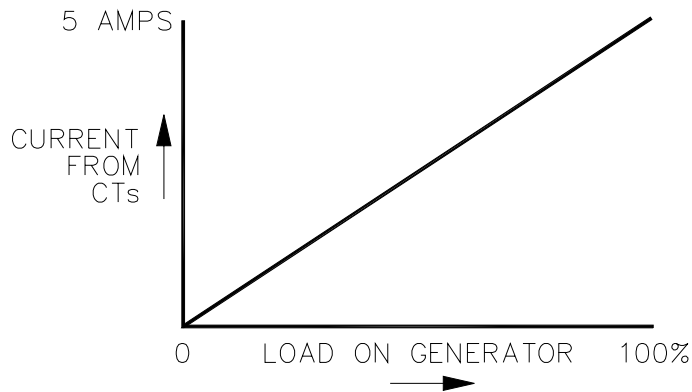

Woodward load sensors are designed to work with 5 A at full load (5 A CTs).

EN-0109  
91-3-16 GA

Figure 6-1. Generator Load Sensor

The induced current from the CTs is added vectorially and then is converted to a dc voltage in the load sensor. However, since only real power is to be used in determining the load sensor output, potential transformers are also connected to the power output leads of the engine-generator. Only CT current which is in phase with the potential transformer voltage is used and converted to a dc voltage in the load sensor. This dc voltage is proportional to the percent of load on the generator. The generator load sensor dc voltage is applied across a "Load Gain Adjust" potentiometer (see Figure 6-2).

### Load Gain Adjust Potentiometer

The Load Gain Adjust potentiometer provides a means of setting a specific voltage, selected from the load sensor output, to represent the load on the engine-generator set. This load gain setting is normally at 6 Vdc for 100% of the set's rated load. The output of the generator load sensor is linear so that voltages from 0 to 6 Vdc represent loads from 0% to 100% of the set's rated load. This load gain voltage is impressed across a balanced load bridge.

## Balanced Load Bridge

### Isochronous

The balanced load bridge (see R1, R2, R3 and R4, Figure 6-2) is a device similar to a Wheatstone bridge. In our bridge,  $R1=R2$  and  $R3=R4$ . As long as the voltage developed across R1 equals the voltage developed across R3, which also means that the voltage developed across R2 equals that across R4, there is no voltage differential across C. The output of the load bridge to the summing point is zero. This is true regardless of the load gain voltage. The control is isochronous. The load does not affect the speed or frequency.

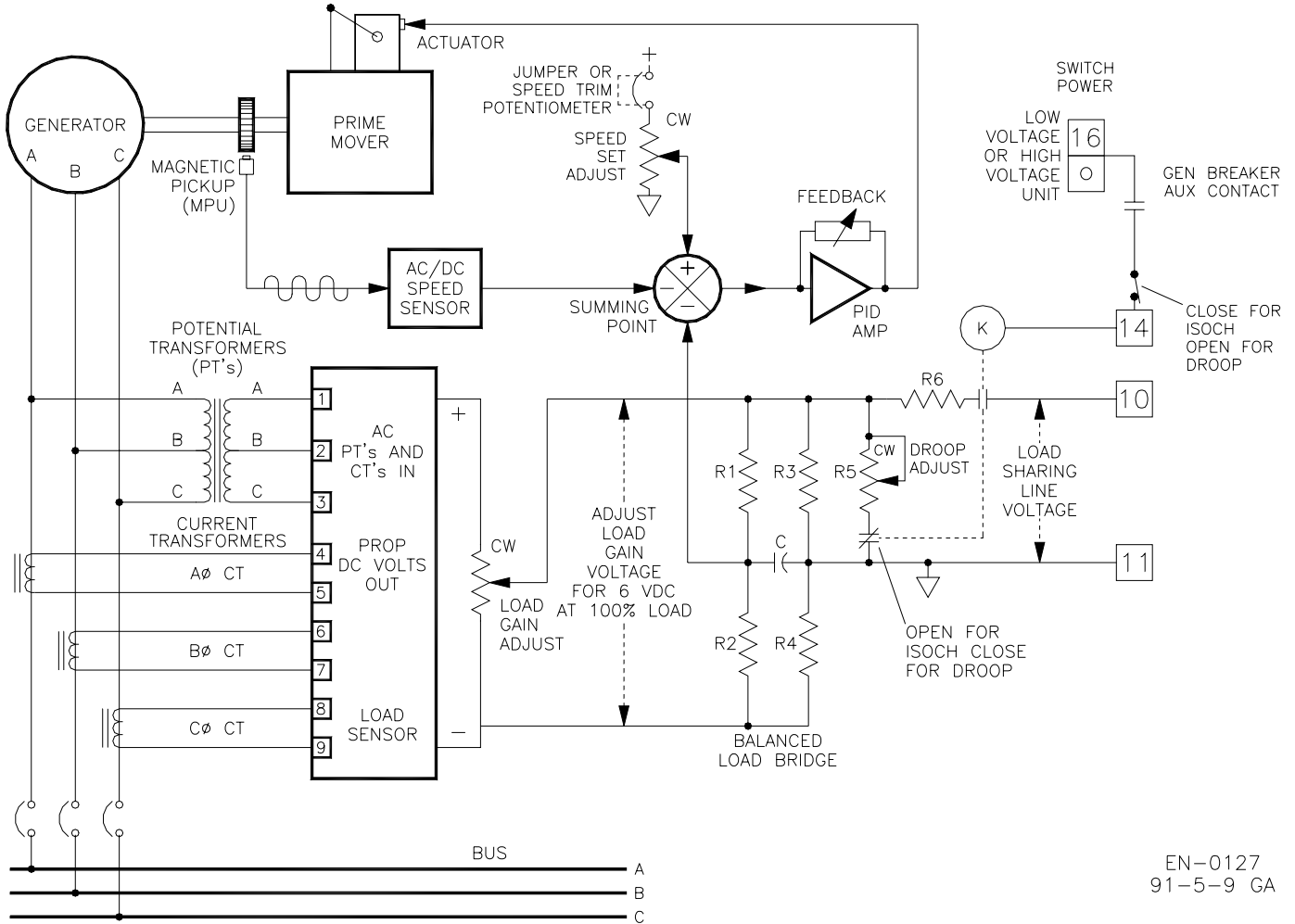

Figure 6-2. Balanced Load Bridge

EN-0127  
91-5-9 GA

## Droop

The load bridge may be unbalanced by either changing the value of a resistor in one leg of the bridge or by applying an unbalancing voltage across one leg of the load bridge. If you unbalance the load bridge by paralleling R5 with R3, the resulting resistance of (R3, R5) is less than R4. The voltage developed across (R3, R5) will be less than that developed across R4. The voltages developed across R1 and R2 are each still at 1/2 the load gain voltage. A voltage is now present across C with a value that will be determined by the load gain voltage and the amount of imbalance caused by R5 in parallel with R3. The voltage across C applied to the summing point will be negative with respect to circuit common. C is not required to make the bridge work. The time to charge and discharge the capacitor slows down the load bridge action. This is necessary to ensure that the load bridge is not faster than the speed loop. If it is, oscillation will result.

At the summing point, the negative signal from the load bridge adds to the negative signal from the speed sensor. To obtain a summing point balance, the amplifier will act to reduce the speed until the sum of the two negative input signals equals the positive input signal from the speed set adjust. The control is in droop. The speed or frequency will decrease proportionally with addition of load.

To return the system to rated speed, it will be necessary to either increase the speed set adjust voltage or to re-balance the bridge and return the system to isochronous control.

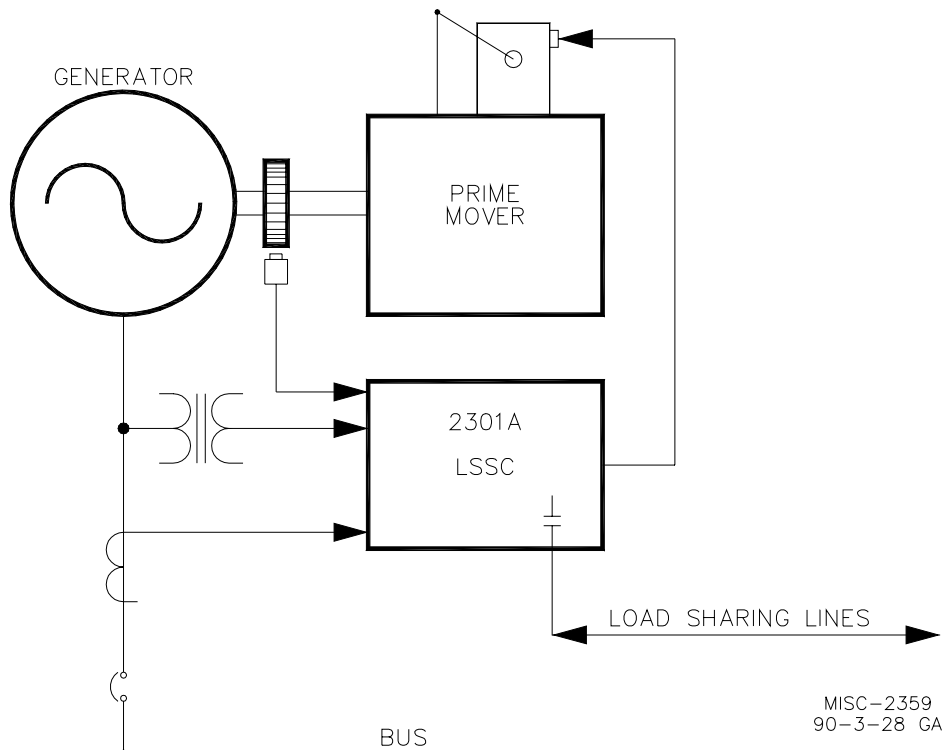

Figure 6-3. Basic Load Sensing Block Diagram

## Load Sharing

The action of the load bridge is also used to bring about isochronous load sharing. Instead of unbalancing the load bridge by changing the resistance of one leg of the bridge, parallel one leg of a bridge from the control on one engine-generator set with the corresponding bridge leg of the control of a second engine-generator set (see Figure 6-4). As long as both sets are providing the same voltage across these connected lines, there will be no imbalance to the load bridge. The summing point is then returned to zero when the speed set and speed sensor signals are equal.

Take two engine-generator sets and adjust each set's load gain for 6 Vdc at 100% of that set's rated output. The voltage developed across R3 of each balanced bridge will be 1/2 of that set's load gain voltage or 3 Vdc at 100% of rated load. Start one set and load it to 100% of rated load. Start the second set and bring it on line at zero load. Simultaneously, when paralleling the two sets, connect the R3 leg of the balanced bridges of the two sets together by means of the load sharing lines (see Figure 6-4).

The voltages across the two R3s are different at the time when set two is brought on line. The R3 of set one is at 3 Vdc, indicating 100% load, and that of set 2 is zero, indicating no load. These differences will balance out through R6 and R3 to a voltage between zero and 3 volts. Both load bridges will be unbalanced, but in the opposite sense. The voltage developed across C of the first unit will call for reduced fuel and that of the second for increased fuel. This imbalance will disappear as the two generator sets approach the same percentage of rated output.

Where both engine-generator sets are of the same output rating, the outputs of the two units will both come to 50% of their rated load. The load gains will both be at 3 Vdc and the voltages across the R1s and R3s will all be 1.5 Vdc. The bridges of both sets are balanced. The bridge outputs are zero, and the sets are in isochronous load share at rated speed. Voltage across the load sharing lines would be 1.5 Vdc.

If the oncoming engine-generator set is rated at only one-half that of the first set's rating (say the first was rated at 100 kW and the second at 50 kW), balanced load would be achieved when each engine-generator set is carrying its proportional share based on its rated output.

$$\text{Rated share } X = \frac{100 \text{ KW Load}}{100 \text{ KW} + 50 \text{ KW}} \text{ or } X = 2/3 \text{ or } 66.67\text{percent}$$

Load gain outputs would match at 2/3 of 6 Vdc or 4 Vdc. Voltages across the R1s and R3s would be 2 Vdc. The load bridges would return to balance when the first machine was carrying 66.67 kW and the second would be carrying 33.33 kW. The sets are in isochronous load share rated speed. Voltage across the load sharing lines would be 2 Vdc.

This method of connecting the load bridge between controls of multiple engine-generator sets, which are supplying the same load, can be used to obtain load sharing between a number of different sets (see Figures 6-5 and 6-6). The maximum number of sets which can be controlled in this manner has not been determined. One known installation has 21.

## Power Output Sensor

The load sharing of mechanical loads or of mixed electrical and mechanical loads uses a different type of load sensing. The most desirable method of sensing load would be to measure the torque on the engines, but this is difficult and requires very special measuring devices. The more common method, based on the assumption that power output is relative to actuator position, is to use a signal developed from the control output (either current or voltage) to the actuator coil. Here, the current is the more desirable since force at the actuator is based on ampere turns. If the actuator coil resistance changes with temperature, the change does not affect the current load signal.

Another signal that can be used is one developed from the fuel valve position. This method makes use of Hall effect devices or of either LVDTs or RVDTs (linear or rotary variable differential transformers). These devices require modulators/demodulators to supply an ac voltage to the position sensors and to rectify the return signal. A dc signal is developed representing fuel valve position. For load sharing these dc voltages relative to output load do not have to be exactly linearly proportional to the load to be useful for load sharing. They do need to be equal from each engine in the load sharing system for any particular percent of each engine's load capability. Again, the sensor output is impressed on a load gain adjustment potentiometer.

The above load sharing analysis can also be applied to a system using power output sensors to accomplish load sharing. The summing point amplifier in the control of each engine will integrate to a fuel position which brings the load bridges in each control to balance. This will set the fuel system of each engine to the same power output whether the load on a particular engine is electric, mechanical, or a combination of electric and mechanical. The actual load sharing will depend on how closely the fuel systems of the different engines track for the same percentage of rated load.

## Isochronous Base Load

If an engine-generator set is under the control of a load sharing and speed control or if it is in an isochronous load sharing system, connecting the system to a utility will fix the speed sensor input to the summing point. Since the speed set is also at a fixed setpoint and the system is in isochronous, one of two things will happen. Either the system will be motorized or it will go to overload. The summing point, having all inputs fixed, cannot correct what it sees as an imbalance. If the system was at a frequency slightly below that of the utility, the speed sensor will send a signal to the summing point in excess of the setpoint input. The amplifier will integrate in a decreased-fuel direction, cutting fuel to the engine. The utility then ends up driving the system. If the system frequency was slightly higher than the utility, the speed signal to the summing point would be below the setpoint, resulting in increased fuel until the mechanical stops are reached.



To prevent these two conditions and to set the desired load, an auxiliary bias signal can be applied to the system load sharing lines. This will set a demand on the generating system to generate a given portion of each engine-generator's rated output. The action is the same as when load sharing units unbalance the balanced load bridges. The load bridge outputs to the individual set summing points will be either positive or negative based on whether the engines are to pick up load or to shed load. Again, when the output of the engine-generators balance the voltages on the load bridge, the system will be at the desired load. The summing point can now function to correct imbalances and the system is under isochronous base load control.

If we now connect such an isochronous load sharing system to a utility, where the speed/frequency is fixed by the utility, and we place a fixed bias signal on that system's load sharing lines, all units in that system will be forced by load bridge imbalance to carry the load demanded by the bias signal. This control method opens many possibilities for load management through Isochronous base loading.

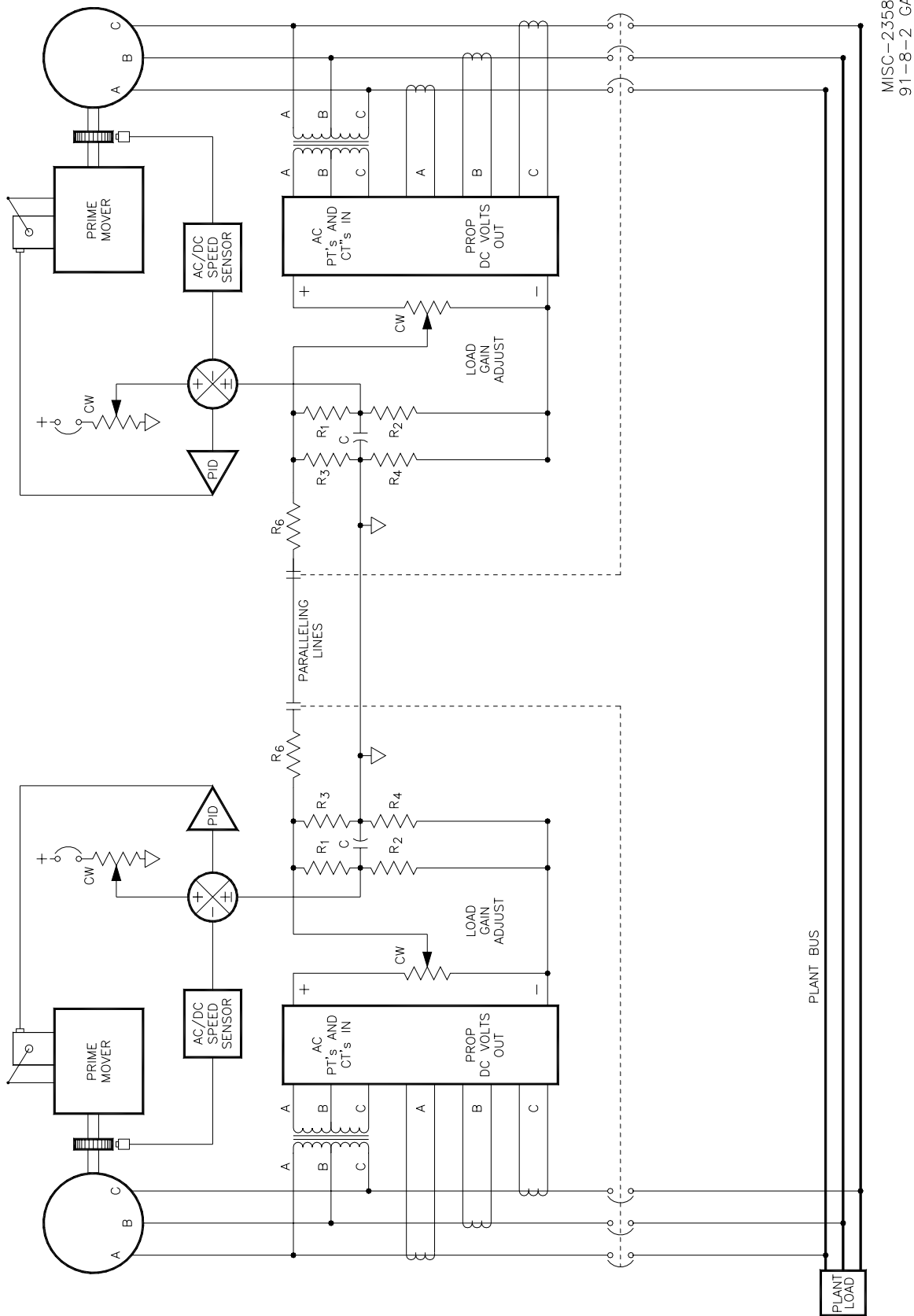

Figure 6-4. Load Sharing Diagram

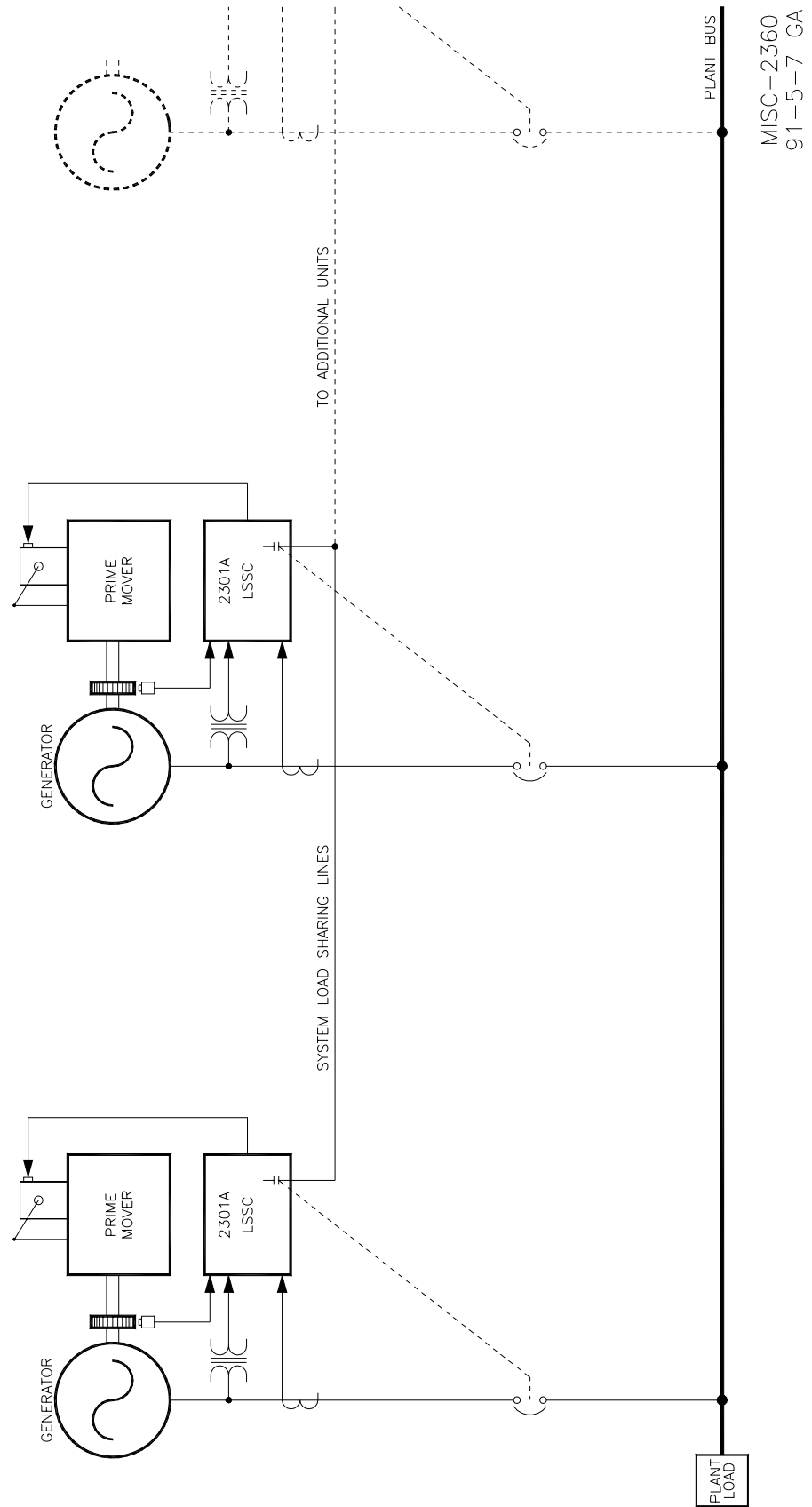

Figure 6-5. Load Sharing Block Diagram

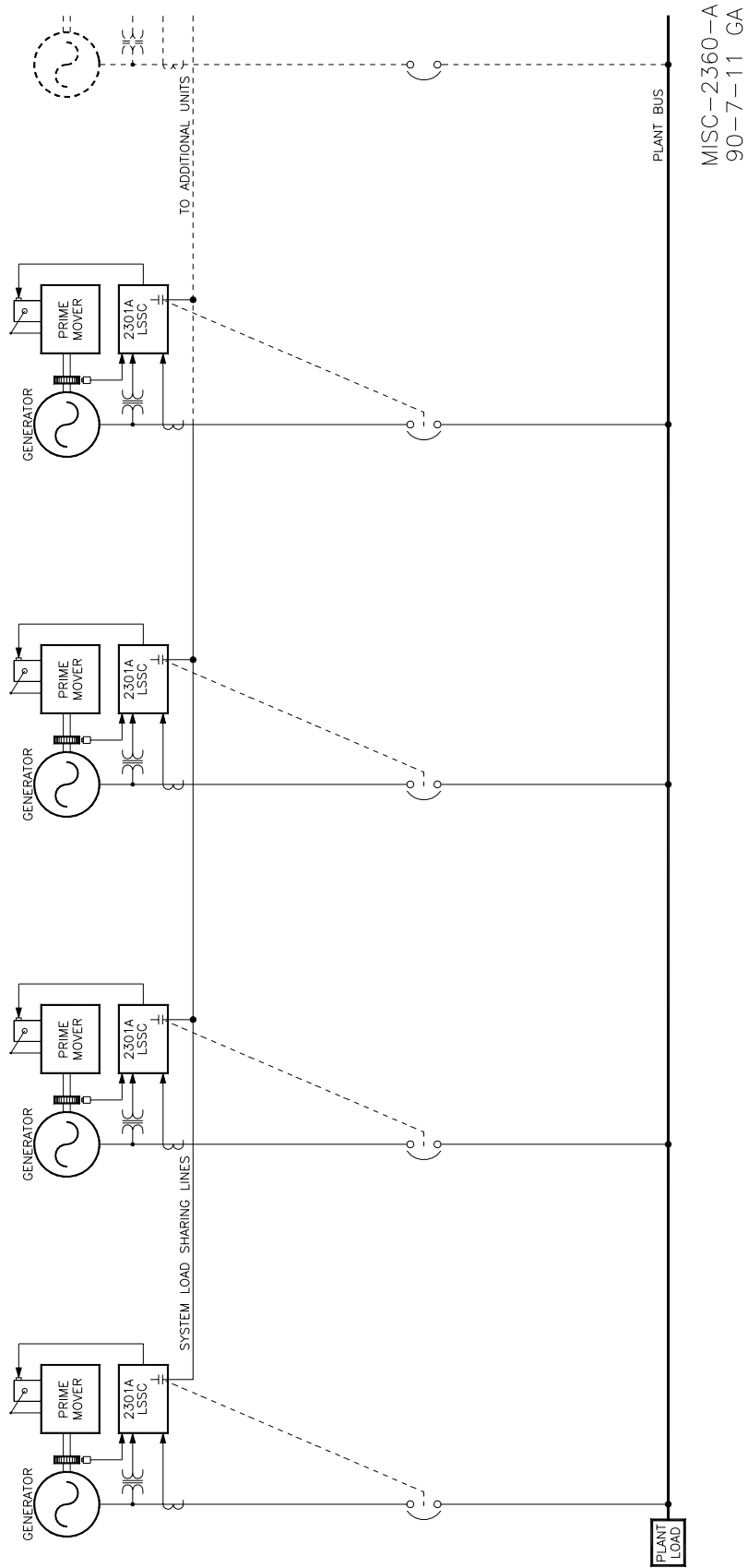

Figure 6-6. Multiple Load Sharing Block Diagram

# Chapter 7.

## Synchronization

### What Is Synchronization?

We have talked about synchronizing one generator to another or to a utility, but what are we actually describing when we use the word "synchronization"?

Synchronization, as normally applied to the generation of electricity, is the matching of the output voltage wave form of one alternating current electrical generator with the voltage wave form of another alternating current electrical system. For two systems to be synchronized, five conditions must be matched:

- The number of phases in each system
- The direction of rotation of these phases
- The voltage amplitudes of the two systems
- The frequencies of the two systems
- The phase angle of the voltage of the two systems

The first two of these conditions are determined when the equipment is specified, installed, and wired. The output voltage of a generator usually is controlled automatically by a voltage regulator. The two remaining conditions, frequency matching and phase matching, must be accounted for each time the tie-breaker is closed, paralleling the generator sets or systems.

### Number of Phases

Each generator set of the oncoming system must have the same number of phases as those of the system to which it is to be paralleled (see Figure 7-1).

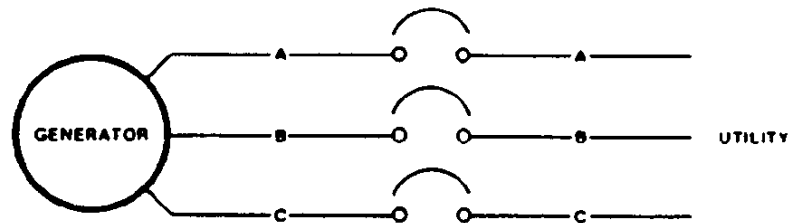

Figure 7-1. Number of Phases Must Match Number Of Phases

### Rotation of Phases

Each generator set or system being paralleled must be connected so that all phases rotate in the same direction. If the phase rotation is not the same, no more than one phase can be synchronized (see Figure 7-2).

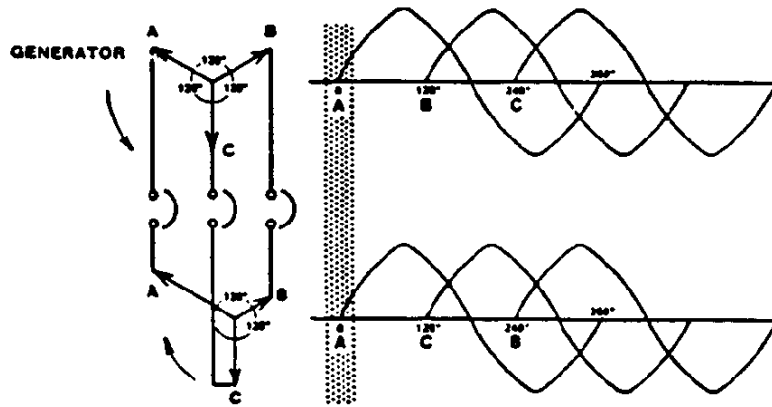

Figure 7-2. Phase Rotation Must be the Same Rotation Of Phases

### Voltage Match

The voltages generated by sets or systems being paralleled must be within a small percentage of the same value, usually 1% to 5%. The output voltage of a synchronous generator can be controlled by changing its excitation voltage. (This is normally done by the voltage regulator.)

If two synchronous generators of unequal voltage are paralleled, the combined voltage will have a value different from the voltage generated by either of the generators. The difference in voltages results in reactive currents and lowered system efficiency (see Figure 7-3).

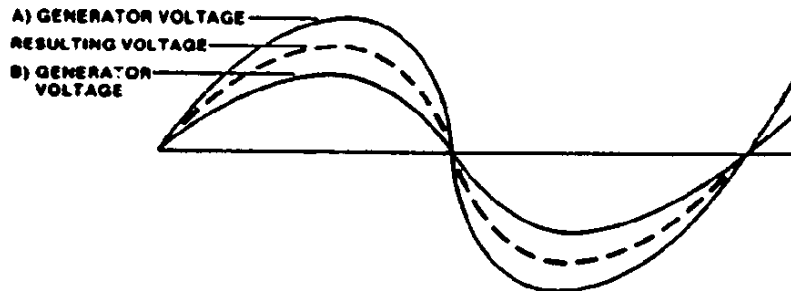

Figure 7-3. Voltage Difference (Generator to Generator)

If, on the other hand, a synchronous generator is paralleled to a larger system such as a utility, a difference in voltages before paralleling will not change the voltage of the bus (see Figure 7-4).

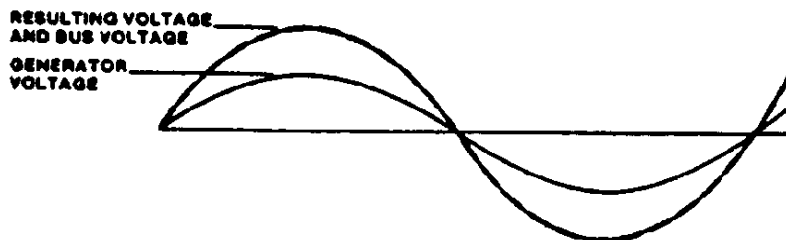

Figure 7-4. Voltage Difference (Generator to Bus)

In this instance, the power factor of the generator will be changed. If the generator voltage is much lower than the bus voltage, the generator could be motored.

An induction generator needs no voltage regulator because its output voltage will automatically match the voltage of the system supplying its field voltage.

## Frequency Match

The frequency of the oncoming generator must be very nearly the same as that of the system it is being paralleled with, usually within 0.2% (see Figure 7-5).

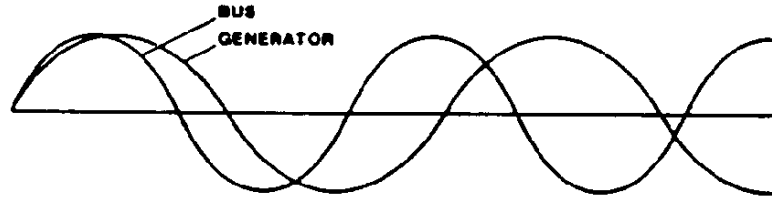

Figure 7-5. Frequency Difference

If the oncoming generator is a synchronous type, this match is normally accomplished by controlling the speed of the prime mover driving the oncoming generator.

If the oncoming unit is an induction generator, frequency is determined automatically by the generator field voltage. Field voltage is supplied by the system to which the generator set is being paralleled. However, the field voltage is not applied to the generator until the tie breaker is closed. The generator must be kept close to synchronous speed prior to breaker closure. A speed below synchronous will cause the oncoming generator to act as a motor, and a speed much over 1.5% above synchronous will cause the induction machine to generate at full capacity.

## Phase Angle Match

The phase relationship between the voltages of the systems to be paralleled must be very close prior to paralleling. This match usually is within plus or minus 10 degrees. If the oncoming generator is a synchronous type, phase matching, like frequency matching, is accomplished by controlling the speed of the oncoming generator's prime mover. If the machine to be paralleled with the system is an induction generator, the phase match will be automatic, since the system is supplying the generator field voltage.

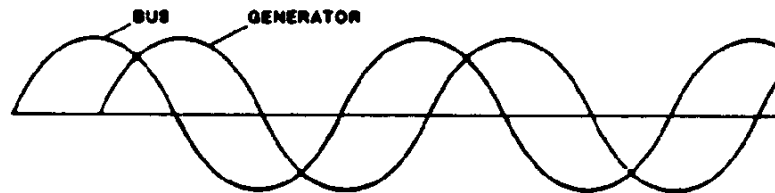

Figure 7-6. Phase Difference

For the synchronous generator, voltage, speed/frequency, and phase, must be matched each time before the paralleling breakers are closed. If the oncoming generator is an induction-type with the armature rotating at synchronous speed, no difficulties will occur when the paralleling breakers are closed. Currently, most installations use synchronous generators. The advantage of synchronous generators over induction generators is that synchronous systems allow independent operation without a utility or other ac power source. Induction generators can not operate without an external ac source.

## Why Is Synchronization Important?

When two or more electrical generating sets or systems are paralleled to the same power distribution system, the power sources must be synchronized properly. Without proper synchronization of the oncoming unit or system, power surges and mechanical or electrical stress will result when the tie breaker is closed. Under the worst conditions, the voltages between the two systems can be twice the peak operating voltage of one of the systems, or one system can place a dead short on the other. Extremely high currents can result from this, which put stress on both systems.

These stresses can result in bent drive shafts, broken couplings, or broken turbine quill shafts. Under some conditions, power surges can be started which will build on each other until both generating systems are disabled.

These conditions are extreme. Stress and damage can occur in varying degrees. The degrading effects depend on the type of generator, the type of driver, the electrical load, and on how poorly the systems are synchronized when the breakers are closed.

Modern systems often supply power to sophisticated and sensitive electronic equipment. Accurate synchronization is necessary to prevent expensive down time and replacement costs.

## How Is Synchronization Accomplished?

Normally, one generating system is used to establish the common bus, and the oncoming generator is then synchronized to that bus by changing the speed of the prime mover driving the oncoming generator.

### Manual Synchronization

Manually synchronized systems rely on monitoring equipment to indicate to the operator when the two systems are synchronized closely enough for safe paralleling. This equipment may include indicating lights, a synchroscope, a synch-check relay, or a paralleling phase switch.

Figure 7-7 shows one method of using two 115 Vac lamps to check whether two voltages are in or out of phase. When the voltages are in phase, the lamps will be extinguished, and when the voltages are out of phase, the lamps will illuminate.

Figure 7-8 shows another method, using four 115 Vac lamps, that will check phase rotation as well as phase match. As before, when the voltages are in phase, all lamps will be off, and when the voltages are out of phase, all of the lamps will light. If pairs of lamps alternate light and dark (with two lamps dark while the other two are light) the phase sequence is not the same.



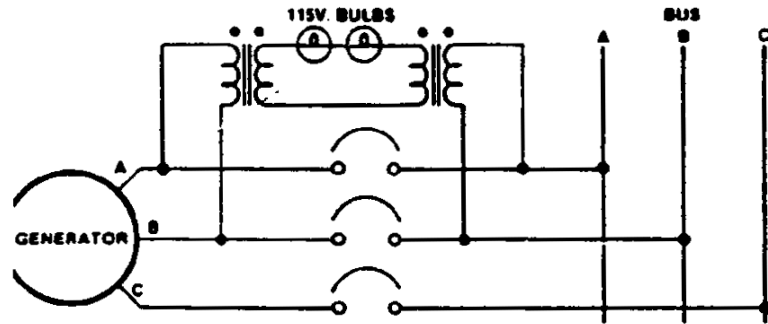

Figure 7-7. Checking Phase Match

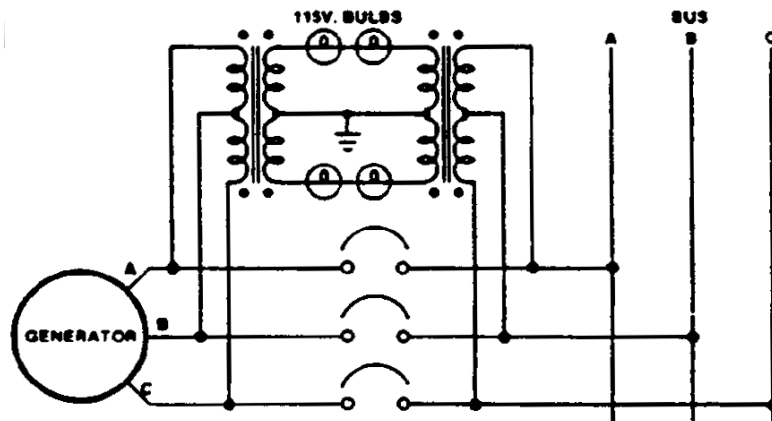

Figure 7-8. Checking Phase Rotation and Match

These manual systems, where the accuracy of synchronization depends on the hands and skill of the operator, are giving way to automatic synchronizing systems.

### Automatic Synchronization

Automatic synchronizers monitor the voltage of either one or two phases of an off-line generator and the voltage of the same phases of the active bus. Small units normally monitor a single phase. Large generating systems normally monitor two phases.

Early automatic synchronizers worked through the speed setting motor-operated potentiometer (MOP). They corrected for speed/frequency only, and relied on a small frequency drift to match the phase of the oncoming generator to that of the active bus.

The time for this type of unit to synchronize varied from 1/2 second upward. Synchronizing depended on how closely the governor controlled speed, and on how closely the synchronizer had matched the generator frequency to that of the bus.

A good governor and an accurate frequency match often resulted in a very slow frequency drift. When this was the case, the time required to drift into phase could result in an unacceptably long synchronizing time.

This method was later improved upon. The synchronizer would bring the oncoming unit into frequency match with the bus. Once the frequency was matched, the speed setting MOP was pulsed, adjusting generator speed to about 0.5% above synchronous speed. The speed setting MOP was then run back to about 0.2% below synchronous speed. This action was repeated until synchronization of phase angle occurred and the circuit breaker was then closed.

A modern synchronizer compares the frequency and phase of the two voltages, and sends a correction signal to the summing point of the governor controlling the prime mover of the oncoming generator. When the outputs of the two systems are matched in frequency and phase, the synchronizer issues a breaker-closing signal to the tie-breaker, paralleling the two systems.

These synchronizers may include voltage-matching circuits which send raise and lower signals to the voltage regulator of the oncoming generator. If the voltage of the oncoming generator does not match the bus within set limits, the synchronizer will not allow a circuit breaker closure.

This system is much faster than the earlier models and can even be used to force an isolated engine-generator to track a utility without actually being connected to it.

## Prediction of the Worst Case Phase Angle Difference ( $\phi$ ) at the Instant of Breaker Closure

Worst case prediction of phase angle difference assumes there is no generator speed correction from the synchronizer after the breaker closure signal is issued (as in the permissive mode). In the run mode, the synchronizer continues to adjust generator speed toward exact phase match during the period the breaker is closing. This provides even better synchronization than the calculations indicate.

The following calculation can be performed to determine if the speed and phase match synchronizer will provide adequate synchronization before the breaker contacts engage in the permissive mode.

Each generator system has a worst case or maximum-allowable relative phase angle ( $\phi_{wc}$ ) that can be tolerated at the time of breaker closure. If  $\phi_{wc}$  and the breaker time delay ( $T_b$ ) are known, the synchronizer's phase window ( $\phi_w$ ) and window dwell time may be chosen to ensure that  $\phi$  is less than  $\phi_{wc}$  when the generator breaker contacts engage. The synchronizer will not issue the breaker closure command unless  $\phi$  is within the window ( $\phi \leq \phi_w$ ) and has been there for at least the window dwell time. The drawing (Figure 7-9) shows the relative values of  $\phi$  and assumes the bus voltage is fixed and pointing straight up.

The relative phase angle, at the instant the main generator breaker contacts engage, depends on many things. The worst case value would exist when the synchronizer is in the permissive mode and therefore is not actively correcting the phase angle during the window dwell time and breaker closing time.

Assuming  $\phi$  continues to rotate at a constant rate, and that the circuit-breaker time delay ( $T_b$ ), the synchronizer window ( $\phi_w$ ), and selected synchronizer window dwell time ( $T_{wd}$ ) are known, the worst case value which the synchronizer will allow ( $\phi_s$ ) can be predicted.  $\phi_s$  is equal to  $\phi$  at the time the synchronizer issues the breaker closure command ( $\phi_w$  in the worst case) plus the change in  $\phi$  due to the rate of change in  $\phi$  times the breaker delay ( $T_b$  in the worst case). Therefore,  $\phi = \phi_{wc}$  when  $\phi$  (at the instant the breaker closure command is issued) =  $\phi_w$ . The rate of change of  $\phi$  ( $\phi/s$ ) is the total degrees in the window divided by the dwell time of the window or

$$\frac{2\delta_w}{T_{wd}}$$

$$\text{then } \theta_{wc} = \theta_s = \theta_w + \frac{2\theta_w}{T_{wd}} (T_b)$$

**For Example:**

Assume a synchronizer configured for a window of  $\pm 10$  degrees and a window dwell time of 1/2 second. Assume the breaker is never slower than 13 cycles.

$$\text{If } \theta_w = 10^\circ$$

$$T_{wd} = 0.5 \text{ s}$$

$$T_b = \frac{13 \text{ cycles}}{60 \text{ cycles/second}} = 0.217 \text{ s}$$

$$\text{then } \Theta_{wc} = \theta_s = 10^\circ + \frac{2(10^\circ)}{0.5 \text{ sec.}} (0.217 \text{ sec.})$$

$$\Theta_{wc} = 18.7^\circ$$

In comparison, a window of  $\pm 5^\circ$  and a window dwell time of 1 second, using the same breaker.

$$\theta_{wc} = \theta_s = 5^\circ + \frac{2(5^\circ) (0.217 \text{ sec.})}{1 \text{ sec.}}$$

$$\theta_{wc} = 7.2^\circ$$

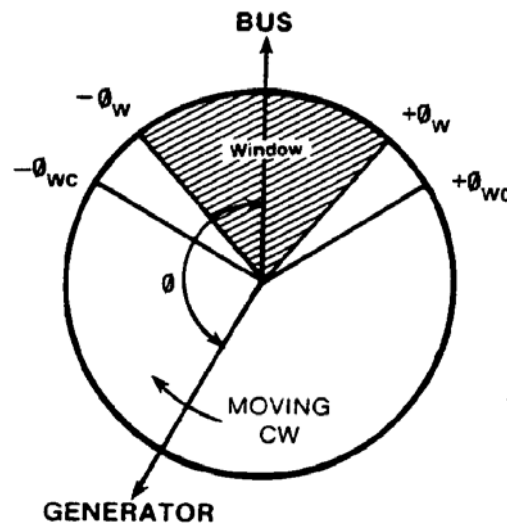

Figure 7-9. Phase Angle Relationship

# Chapter 8.

## Managing Power for the Desired Result

### Peaking or Peak Load Control

Peak sharing, peaking, or peak load control all refer to methods used to limit the peak electrical demand purchased from a utility. Electrical rates usually are determined by the peak demand on the utility during a given time period. Sometimes a peak demand lasting as brief as fifteen minutes out of a 30-day period will determine the charge leveled for all power purchased during those 30 days.

#### How Is Peak Sharing, Peaking, or Peak Load Control Accomplished?

Normally, peak load control is accomplished by one of four methods:

- Plant load control or load shedding, which means the shutting off of optional loads to hold peak consumption below a maximum desired load level.
- Separating off and isolating a portion of the plant load and then powering that isolated portion with an in-plant generating system. Ensure that the plant generator load is a sufficient part of the total load to maintain the utility load below the maximum desired peak.
- Base loading an in-plant generator system which is paralleled to the same plant load supplied by the utility. Set the output of the in-plant generator high enough to ensure that the utility load will not swing above the desired maximum.
- Peak shaving, using an in-plant generator system controlled to take all loads or peaks above a certain level. The utility will take all loads below this level (see Figure 8-1).

#### Base-Loading

Base loading and peak shaving both use base loading techniques: base loading by setting a block or constant load on the in-plant engine generator system, peak shaving by varying the base load to maintain the level of power supplied from the utility at or below a certain level.

Base-loading is the operation of an engine-generator at a constant output. When internal power demand exceeds generator output capacity, deficit power will be imported from the utility. The user's equipment is tied to the utility and uses the utility to control frequency. Base-loading usually is accomplished with the user's equipment in droop with the utility accepting load swings. Equipment is available that will allow the user to operate in isochronous mode with the utility and still allow the utility to accept load swings.

If the base-loading exceeds the plant's internal power demands, the excess power may be exported to the utility.

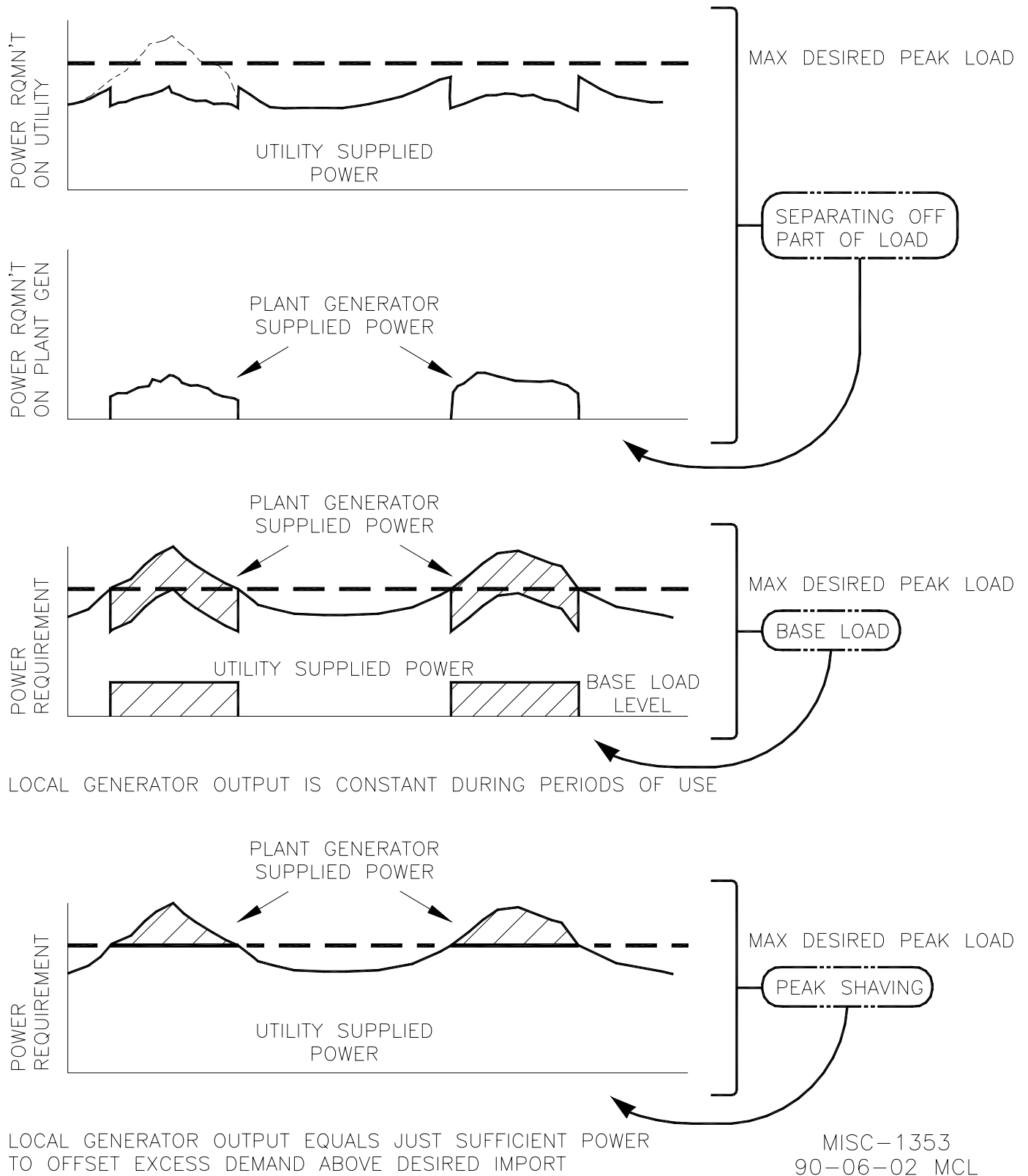

Figure 8-1. "Peaking" or Peak Load Control

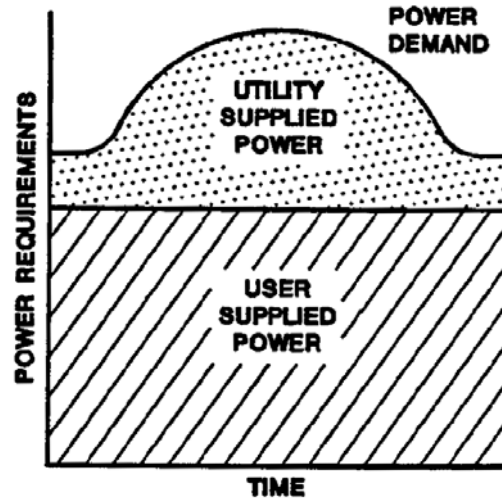

Figure 8-2. Base Loading

### Peak Shaving

Peak shaving is used to set a limit on the maximum amount of imported power. In the following example, a limit of 100 kW is set for imported power, and the user's generating equipment provides for power demands exceeding the 100 kW limit. The in-plant engine generator is normally operated only during periods of peak power demand.

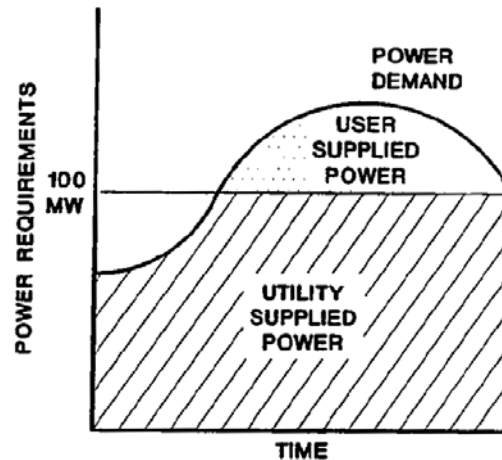

Figure 8-3. Peak Shaving

### Import/Export

Import power and export power are terms used to describe power that is brought into a plant (import) or is sent to a utility (export). A plant may import power during peak demands and export during low demands. Other situations may require only import power or only export power.

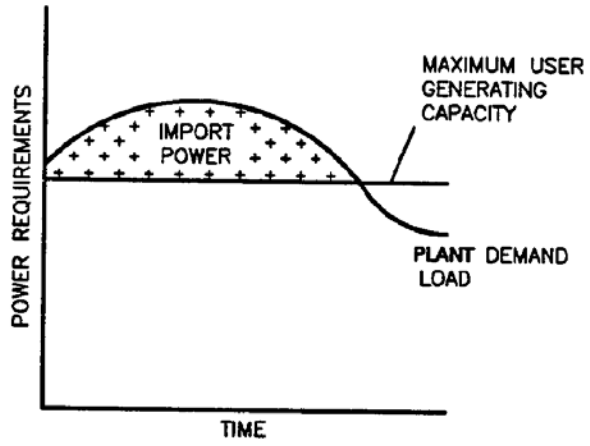

Figure 8-4. Import Power

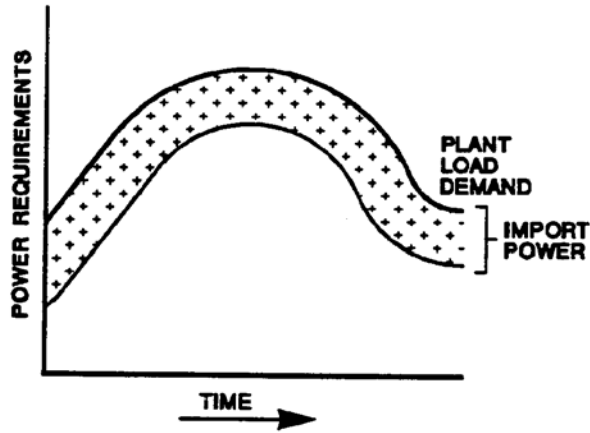

Figure 8-5. Import Power (Constant Level)

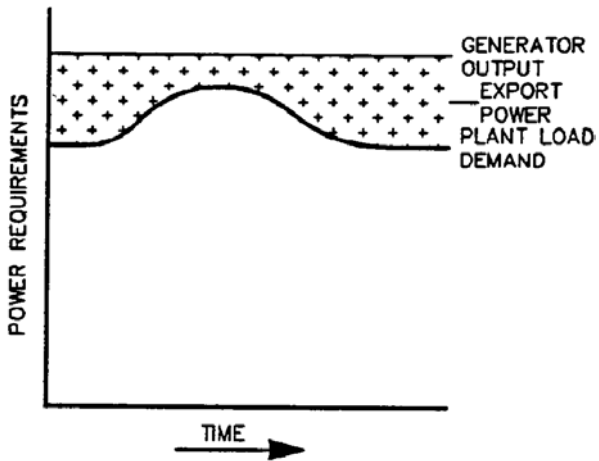

Figure 8-6. Export Power

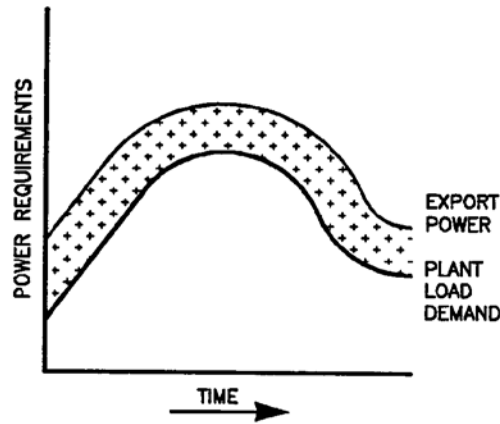

Figure 8-7. Export Power (Constant Level)

### Zero Import (Export) Control

A generator—or series of generators—is able to supply all electrical power required for plant operations. The generator is tied to the utility for frequency control and for emergency situations. Normally power is not exported to, nor imported from, the utility. This situation usually necessitates the start-up or shutdown of engines as power demands fluctuate. Operating isochronous base load, any number of engine generators can be connected to isochronous load share, with the complete system base loaded against the utility.

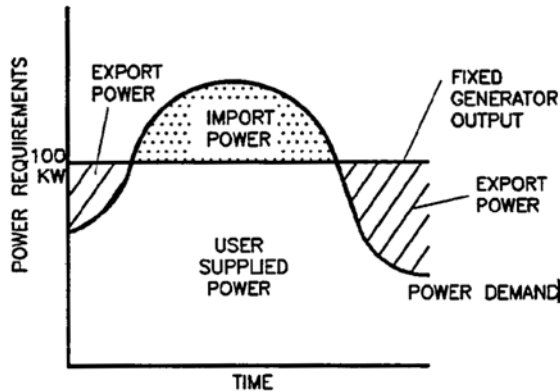

Figure 8-8. Import/Export Control

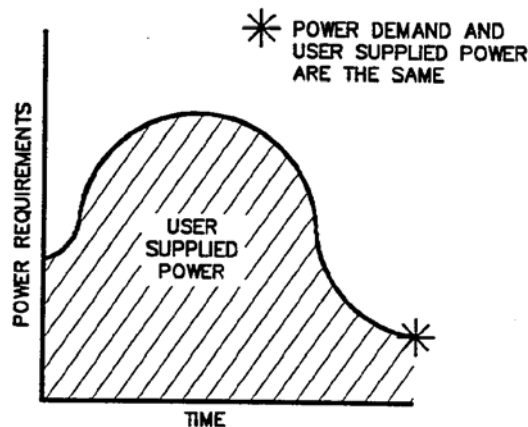

Figure 8-9. Zero Import/Export



## Cogeneration

### What Is Cogeneration?

Cogeneration normally is defined as the combined production of electrical or mechanical power and useful thermal energy through the sequential use of energy.

Systems that burn some form of fuel (combustion energy) to generate electrical power often only produce power outputs of 40% or less of the total fuel energy. Unless power management in the form of cogeneration is used, the remaining energy is lost. This loss is in the form of thermal energy such as exhaust heat and friction heat. With proper applications of cogeneration, much of this lost energy can be recovered and used in applications where a source of heat is required.

Generated electrical power may be recycled into the manufacturing process, or qualified producers may sell it to a utility company. The type of manufacturing process, and its needs, will determine how generated power is distributed.

### How Is Cogeneration Accomplished?

Two recognized cogeneration cycles are the "topping cycle" and the "bottoming cycle."

The topping cycle is a method by which fuel is consumed to drive a prime mover coupled to a generator or other device to produce electricity or shaft power. The heat generated in this process then is used for plant processes.

The bottoming cycle is a method by which waste heat generated during a plant process is used to generate electricity.

Cogeneration can increase the efficient use of energy or fuel by as much as 50%.

### Single Engine AGLC–Base Load Control

(See Figures 8-10, 8-11, and 8-12)

In this application, a single engine can be automatically synchronized and base loaded into the utility. This unit, if the utility tie is broken for any reason, will also operate isochronously, carrying the plant load up to the engine's capabilities.

The following is a typical series of events.

The engine is started under governor control and warmed up at idle speed. After the warm-up period, the engine is ramped up to synchronous speed. The generator field is excited and output voltage is developed. Once the SPM-A synchronizer senses generator voltage, and assuming the utility-to-plant load tie is closed and SPM-A run mode has been selected, the SPM-A begins matching speed, phase, and voltage with the utility. When the requirements of the SPM-A are matched, it issues a one second generator breaker closure command signal to close the breaker. At the same time, auxiliary breaker contacts close and activate the AGLC (Automatic Generator Loading Control).

The AGLC unit load sharing output lines, which are connected to the 2301A load sharing lines, start at zero Vdc and ramp up to the setting of the base load setpoint potentiometer. This AGLC output forces the engine, through the 2301A, to pick up the desired load. If utility power were now lost and the utility tie breaker opened, the AGLC would be automatically de-activated, removing the bias from the load sharing lines. The engine would then automatically carry the plant load, within its capabilities at synchronous speed.

When the utility power returns, the SPM-A, sensing voltage, would automatically begin synchronizing the engine, and once satisfied, close the utility tie breaker, re-activating the AGLC. The AGLC, tracking the load sharing lines, would start out at the plant load at that time, causing no load bump, and ramp the load up or down, back to its base load reference setpoint.

To unload the engine, the AGLC unload contacts are momentarily opened. The AGLC ramps the load off the engine and back onto the utility. Once the engine's load is down to the unload trip level setpoint, the AGLC issues a generator breaker open command. The generator circuit breaker opens and the engine is isolated from the load. The utility now has the system load and the engine can be shut down.

These controls provide a means to totally automate an engine to start, run, load, unload, and shut down, using simple relays, timers, and circuit breaker auxiliary contacts.

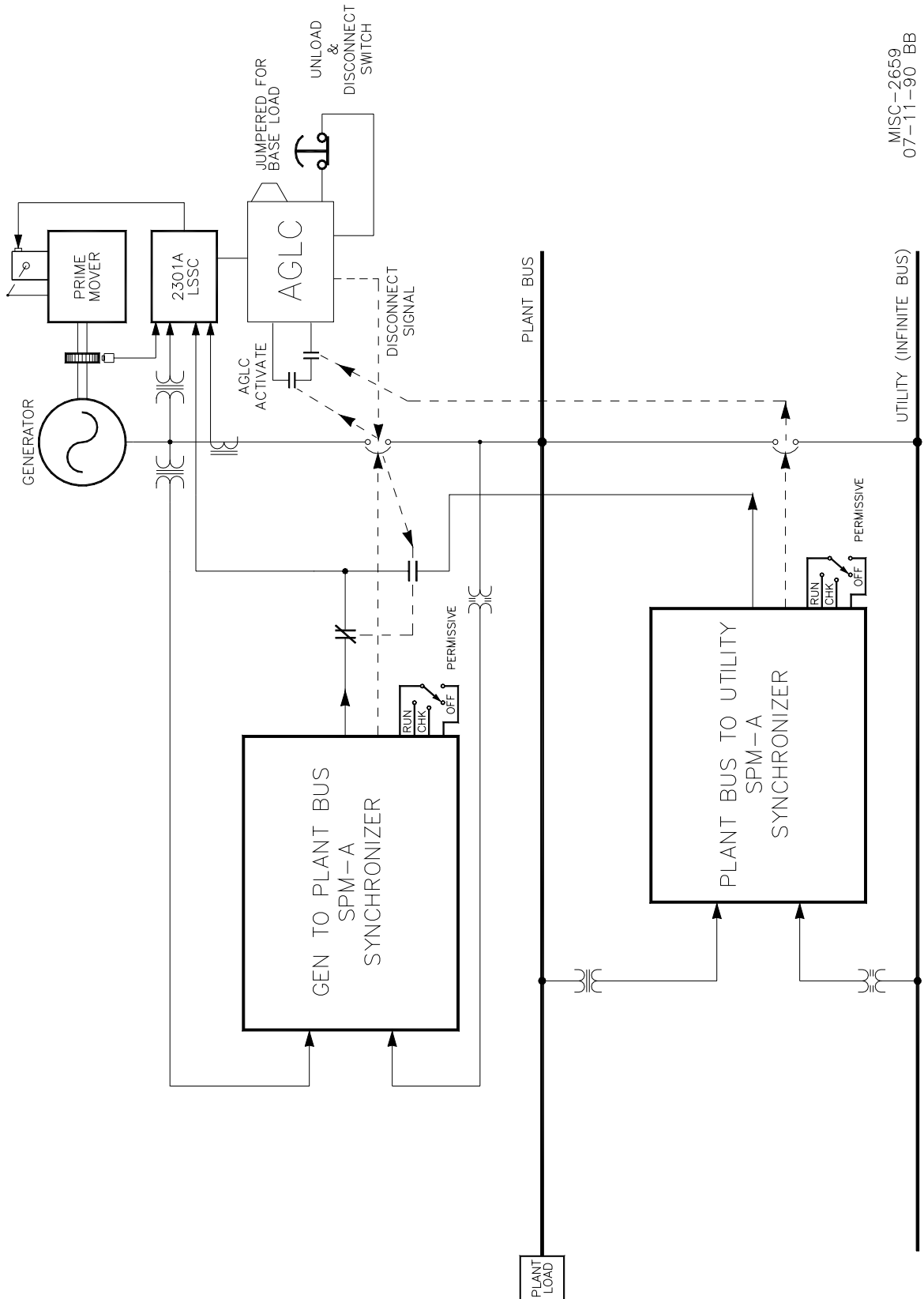

MISC-2659  
07-11-90 BB

Figure 8-10. Synchronizing to Utility or Plant Bus

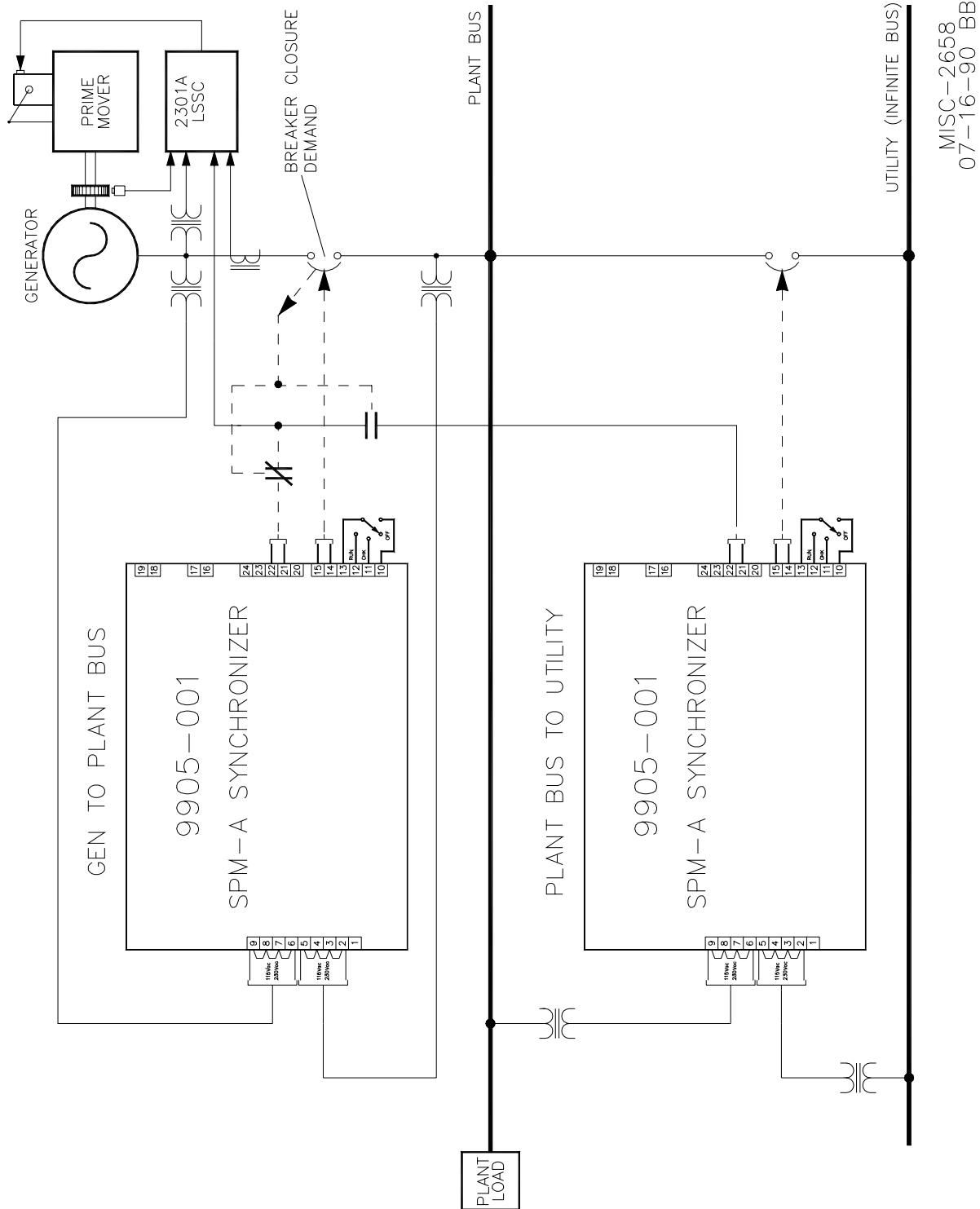

MISC-2658  
07-16-90 BB

Figure 8-11. Synchronizing Gen Set to Plant Bus or to Utility

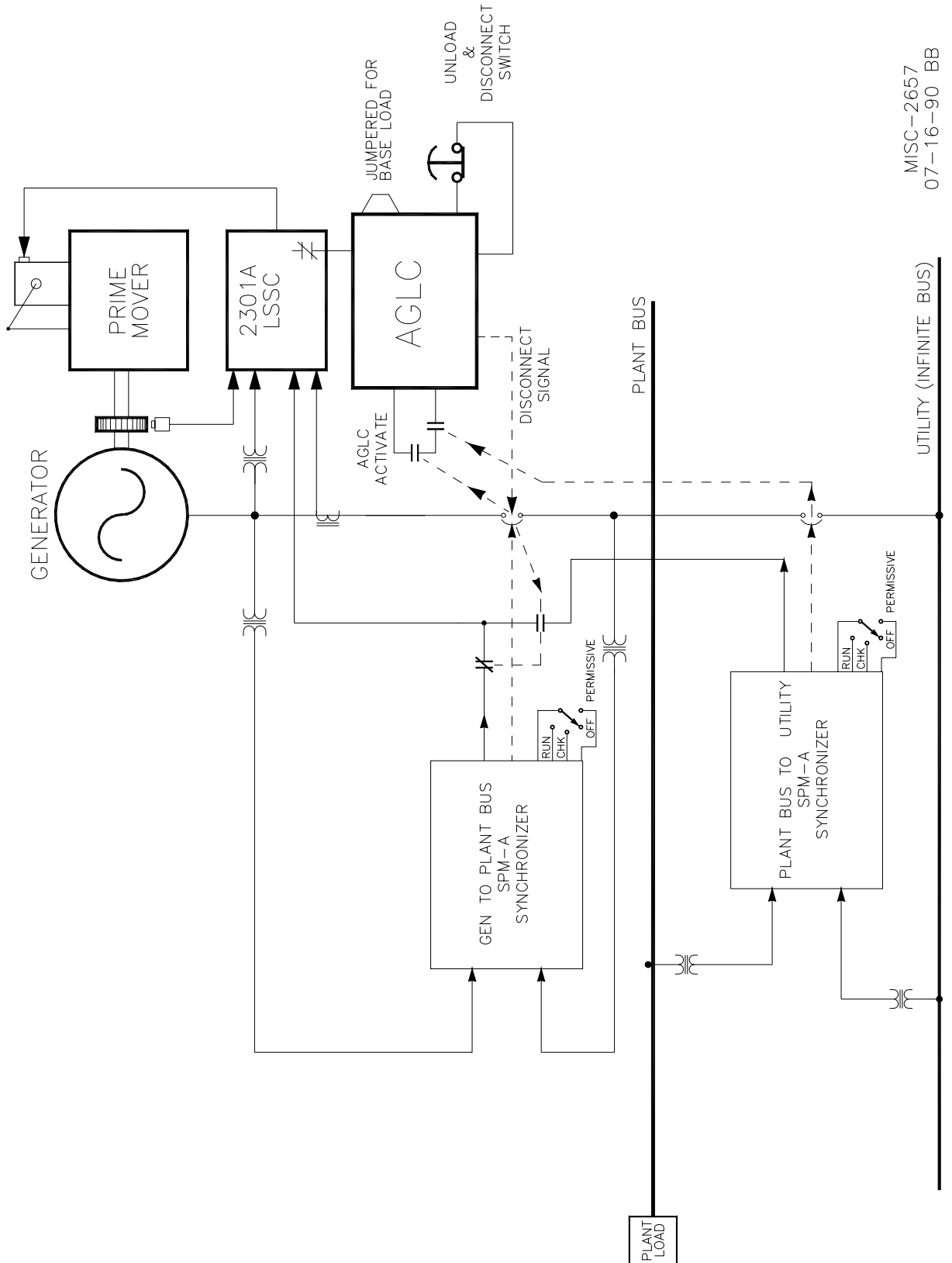

MISC-2657  
07-16-90 BB

Figure 8-12. Single Engine AGLC Base Load

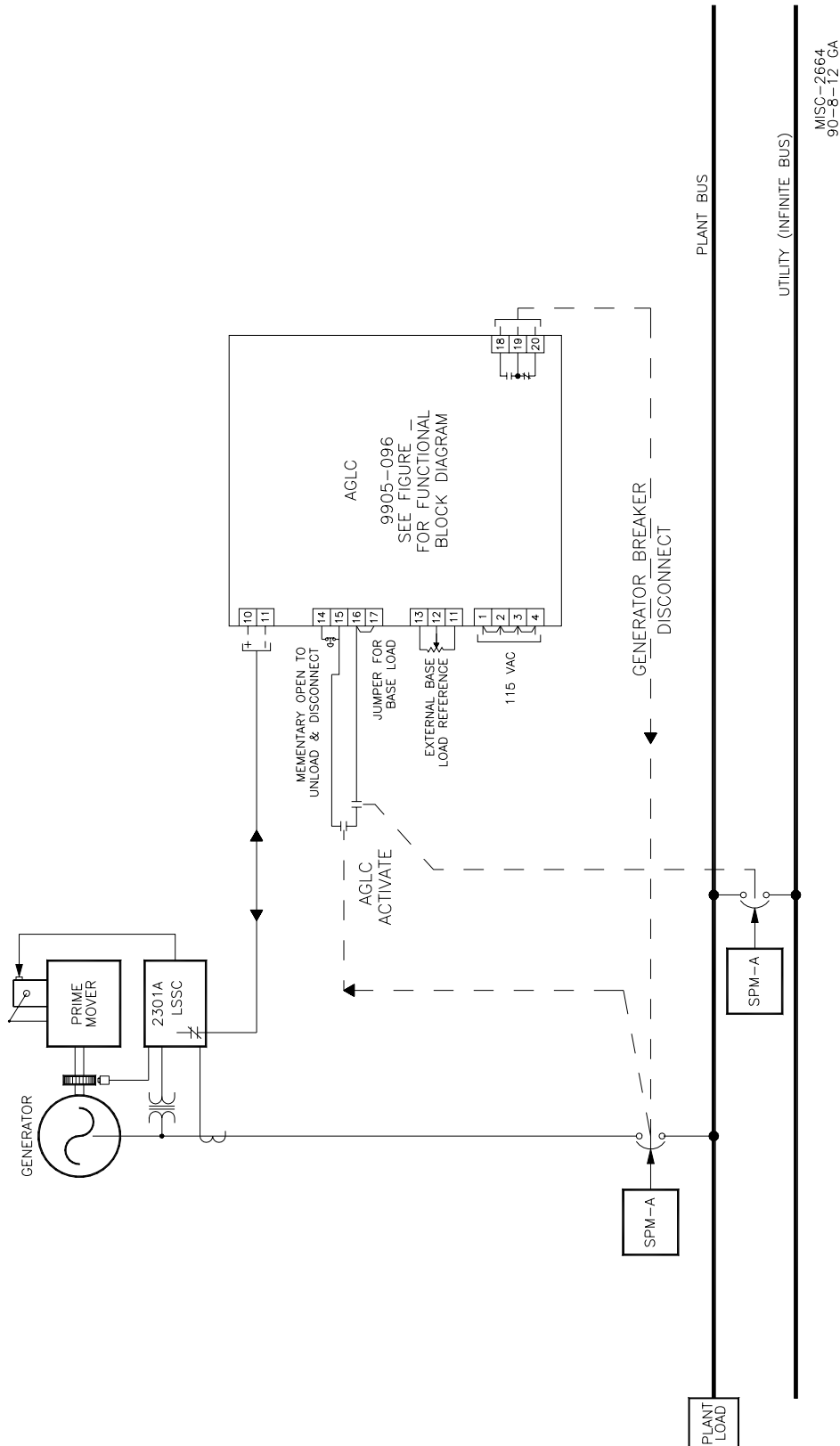

MISC-2664  
90-8-12 CA

Figure 8-13. Connections for Single Engine AGLC Base Load System

## Isolated Bus Isochronous Load Sharing System

Two Or More Engines (2301A)

(See Figures 8-14 and 8-15)

For this application, two or more engines share an isolated load isochronously. They will maintain rated speed regardless of load fluctuations within the engine-generator system's total capabilities. Each engine will carry an equal percentage of its full load rating, with load sharing accomplished through the system load sharing lines attached through the AGLCs.

The AGLC is used to ramp each generator in or out of the system automatically, or it can be used to base load an individual engine.

SPM-A synchronizers are used to automatically parallel the incoming generator, matching speed, phase, and voltage.

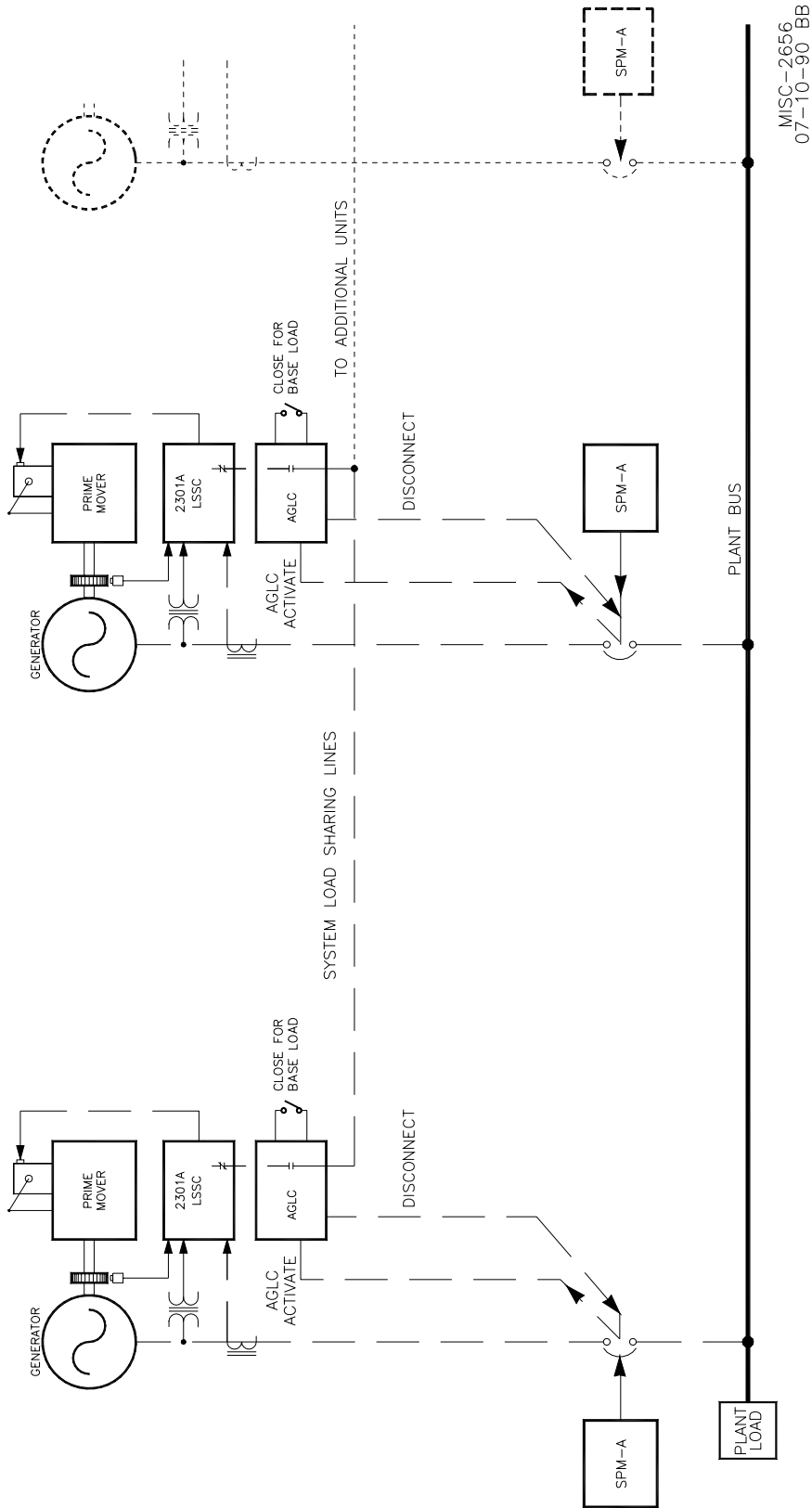

Figure 8-14. Using AGLC for Soft Load, Soft Unload, and Base Load to an Isolated Bus for Isochronous Load Sharing



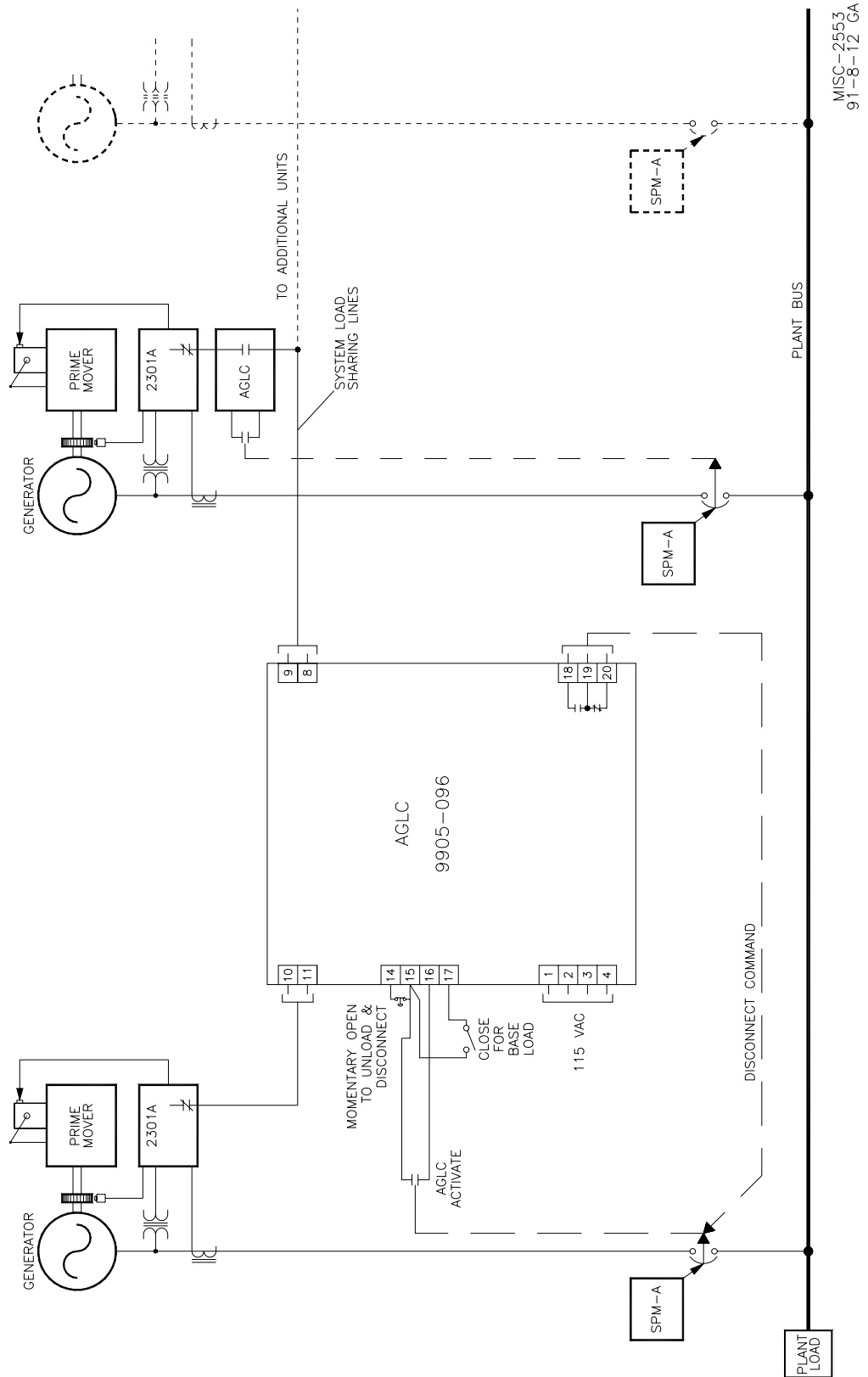

Figure 8-15. Connections Used with AGLC for Soft Loading, Unloading, and Base Loading with Isochronous Load Sharing Against an Isolated Bus

## Multiple Engine AGLC–Base Load Control

(See Figures 8-16 and 8-17)

This application adds to the previous one the option of paralleling to the utility.

The local generation system can be automatically synchronized to the utility and soft loaded up to the internal or external base load setpoint. Individual engines are also automatically synchronized and ramped into the system by each engine's AGLC as needed. Individual engines can also be automatically disconnected from the load sharing lines and controlled in base load utilizing only contact closures for switching logic.

In the event of loss of utility, the master AGLC is automatically de-activated, removing the bias from the system load sharing lines. The generators shed or pick up load maintaining plant load at synchronous speed. When the utility returns, the master synchronizer re-parallels the local bus to the utility, the master AGLC is re-activated, and base loading is resumed, all with no operator intervention.

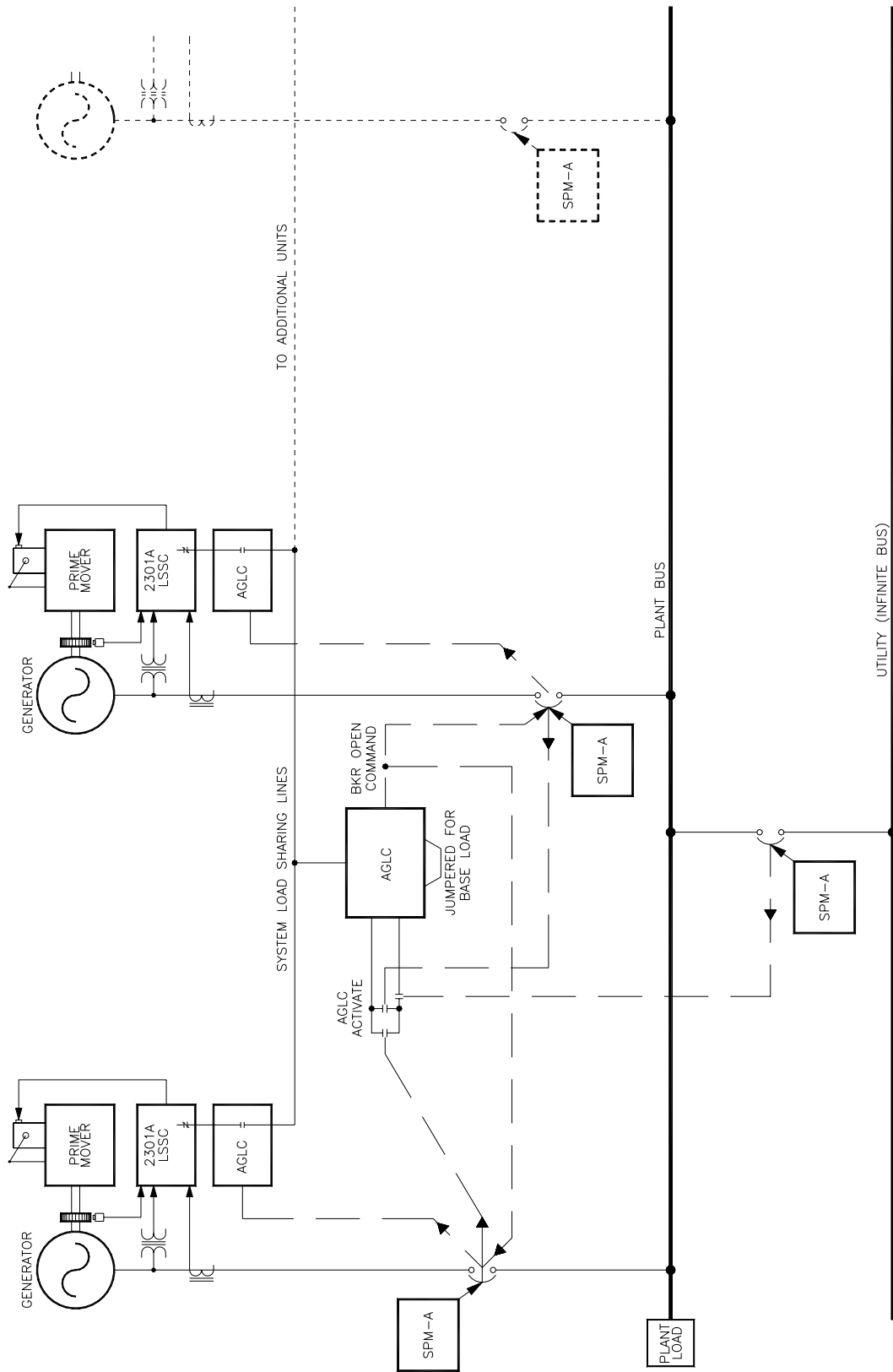

MISC-2552  
92-4-28 GA

Figure 8-16. Using the AGLC to Base Load Multiple Engines to a Utility

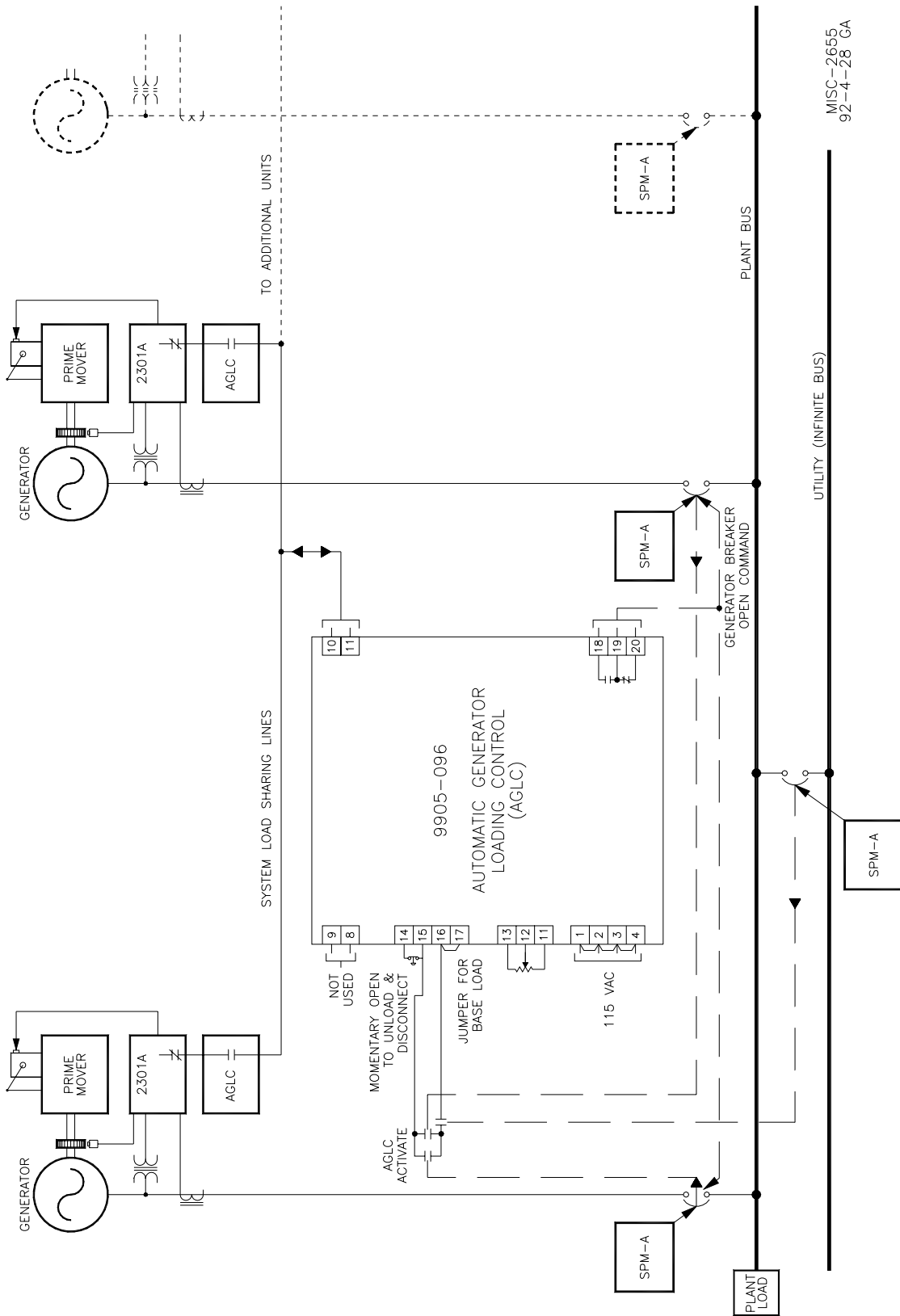

Figure 8-17. Connecting an AGLC to Base Load Multiple Engines to a Utility

## **Automatic Paralleling System (2301A) to a Utility Using a Process-Import/Export Control**

(See Figures 8-18 and 8-19)

A Process-Import/Export Control can be used in systems which parallel to the utility and also control a process such as setting the amount of import or export power while maintaining a minimum gas field pressure or inlet pressure on a turbine. A watt transducer is used as one of the inputs to the process-import/export control to supply a signal representative of the power flowing to or from the utility.

Another common use of such a system is to maintain steam pressure in a plant at a given setpoint using the otherwise waste heat from a generating system.

Synchronizers and Automatic Generator Loading Controls are used to complete the automation as previously described.

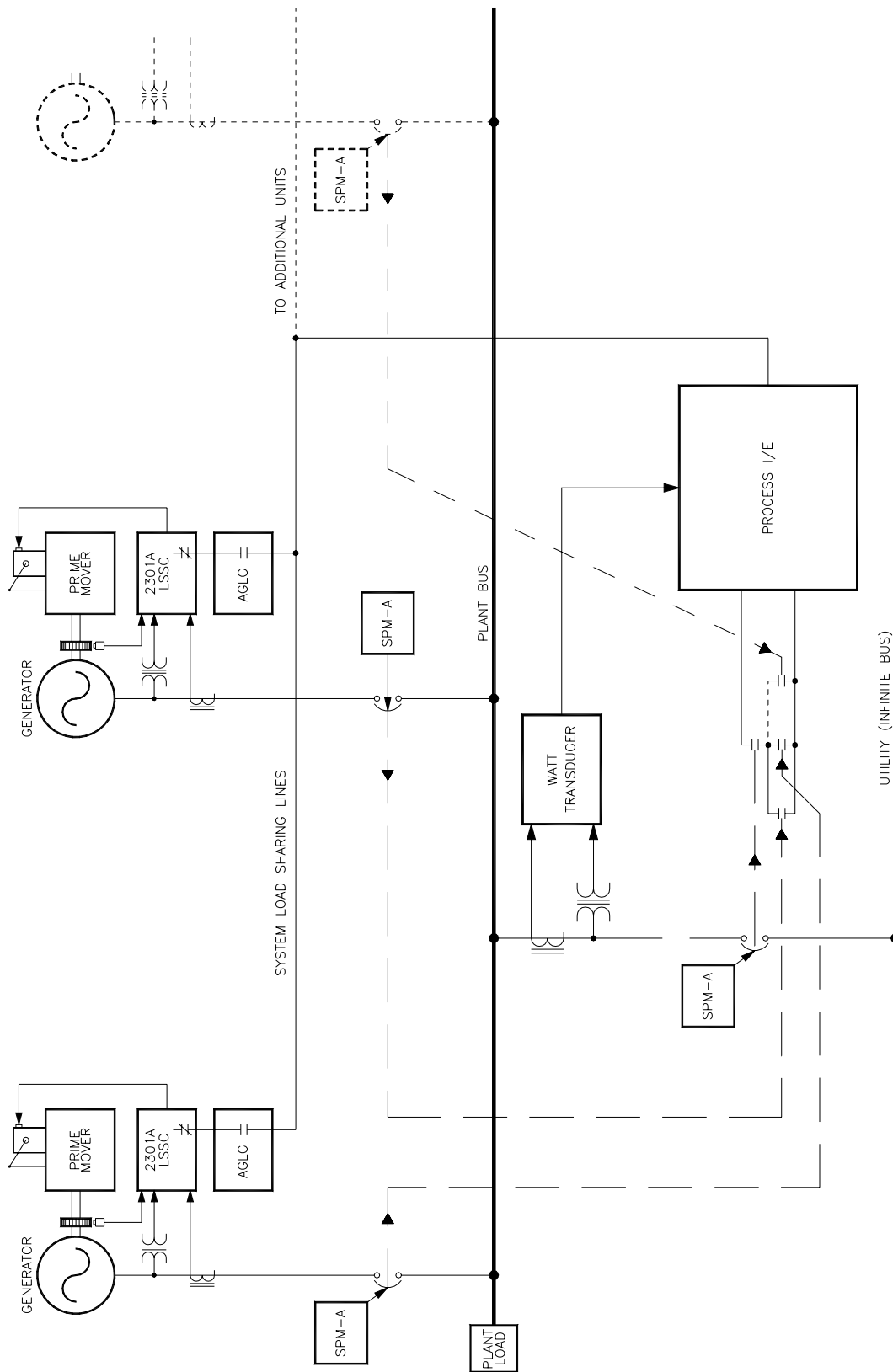

MISC-2614  
90-6-11 GA

Figure 8-18. Using Process-Import/Export Control to Automatically Parallel

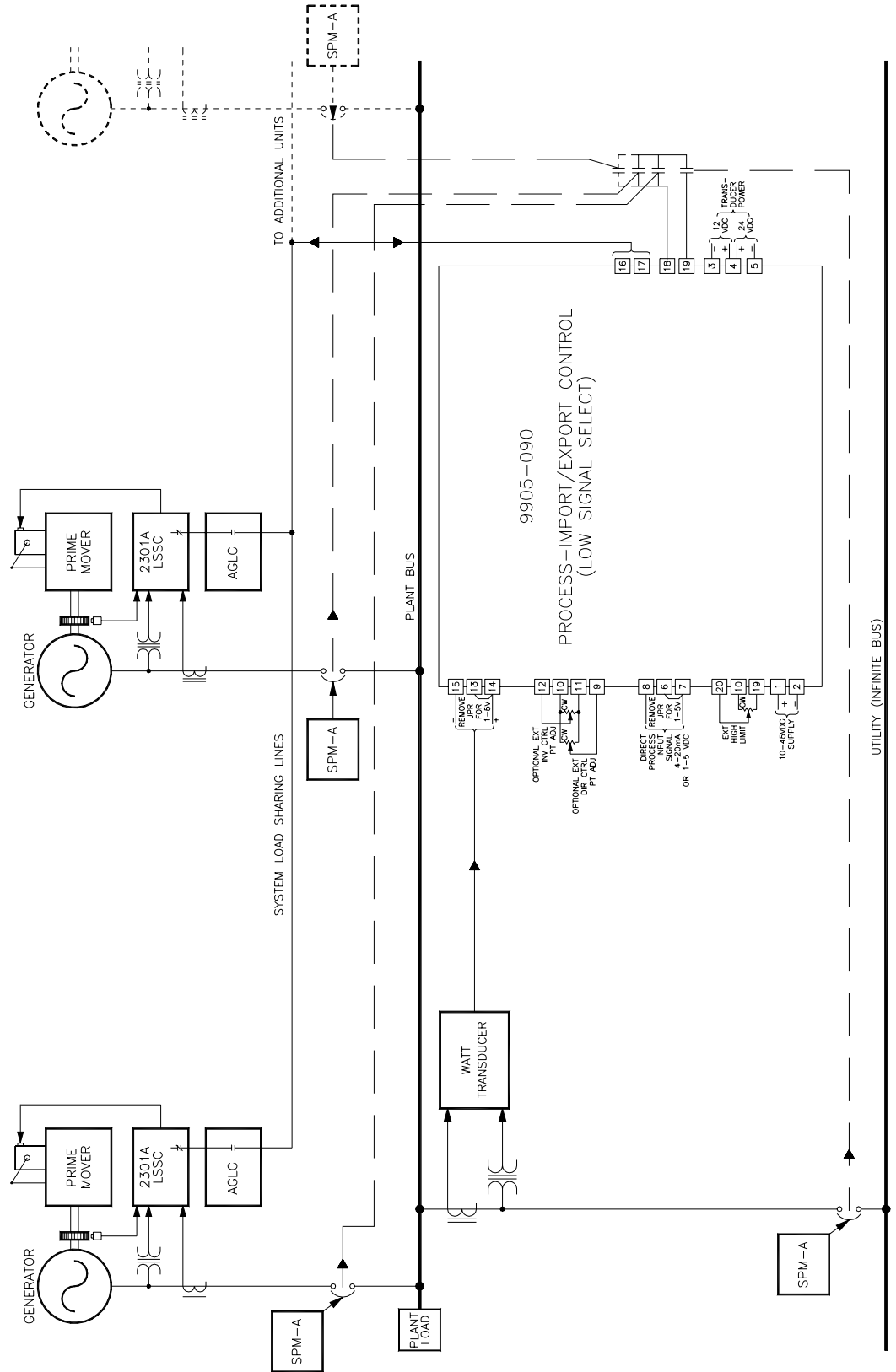

Figure 8-19. Connecting Process-Import/Export Control to Paralleling System

MISC-2556  
90-7-13 GA

## **Automatic Paralleling System (2301A) to a Utility Using an Automatic Power Transfer And Load (APTL) Control**

(See Figures 8-20 and 8-21)

An Automatic Power Transfer and Load (APTL) Control can be used in systems which parallel to the utility, and can also serve as backup plant power generation. The APTL control is used to eliminate power bumps or surges at the moment of joining or of separating two electrical generating systems (local generator system to a utility).

The level of power being generated will be maintained until it is changed by one of five loading or unloading modes. These modes are:

- Loading or unloading contacts
- Internal load set
- External load set, either potentiometer or from a computer or other setpoint controlling device controlling the setpoint
- Utility unload
- Import/Export



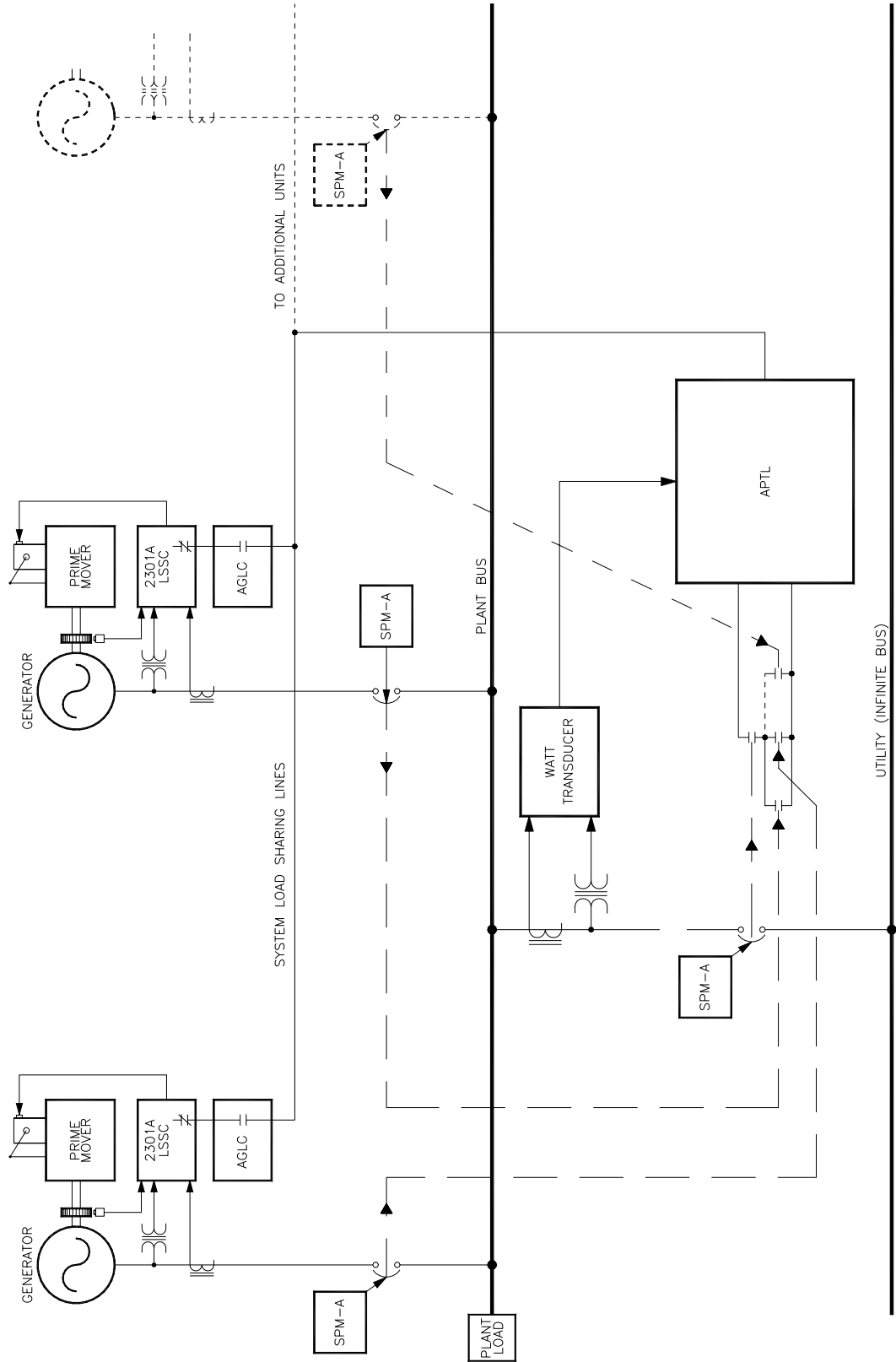

MISC-2554  
90-7-13 CA

Figure 8-20. Using APTL in Automatic Paralleling System

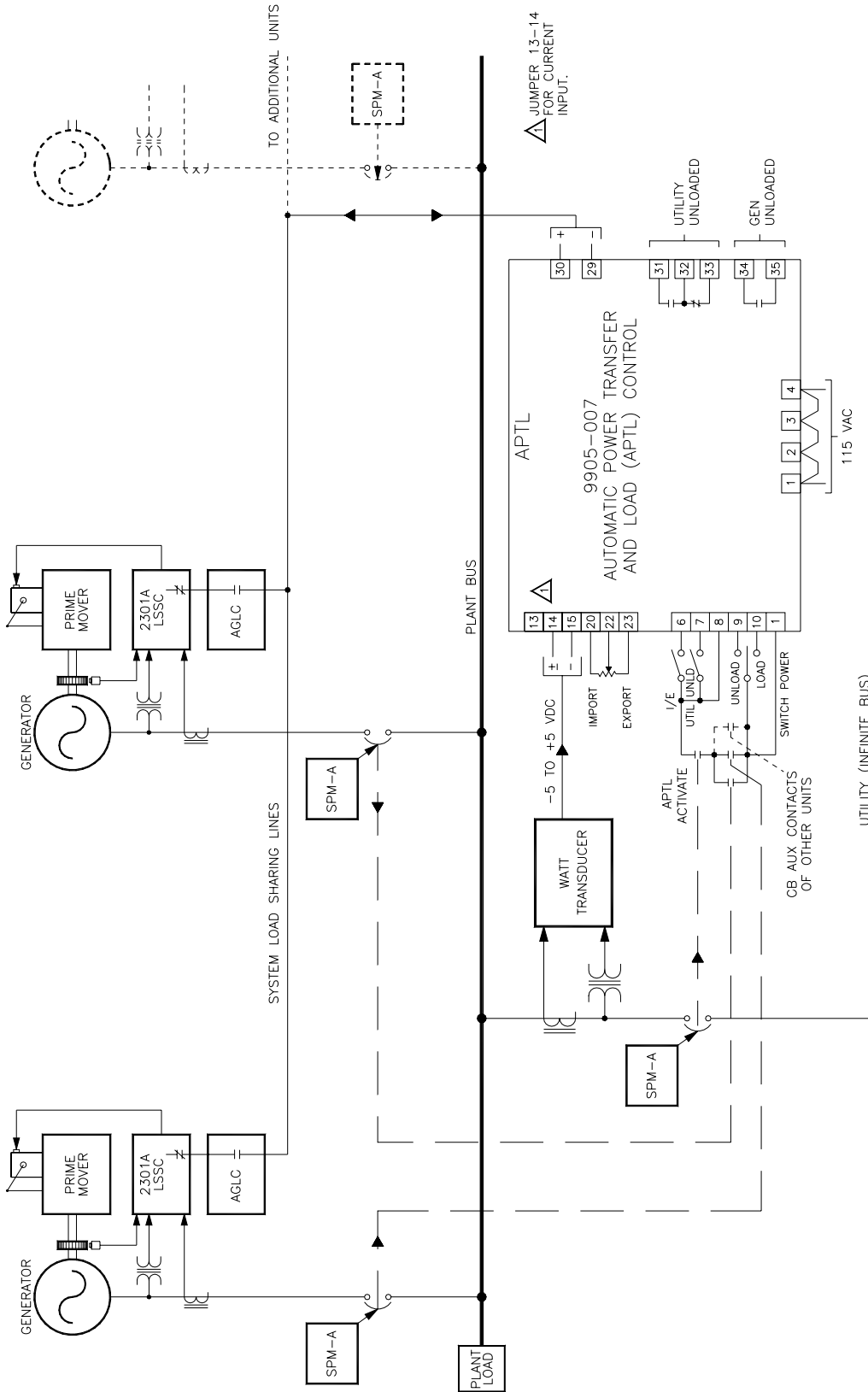

Figure 8-21. Connecting APTL in Automatic Paralleling System

MISC-2555  
91-8-12 GA



We appreciate your comments about the content of our publications.

Send comments to: [icinfo@woodward.com](mailto:icinfo@woodward.com)

Please include the manual number from the front cover of this publication.



PO Box 1519, Fort Collins CO 80522-1519, USA  
1000 East Drake Road, Fort Collins CO 80525, USA  
Phone +1 (970) 482-5811 • Fax +1 (970) 498-3058

**Email and Website—[www.woodward.com](http://www.woodward.com)**



FM 57982  
BS EN ISO 9001:1994  
6 March 2001

**Woodward has company-owned plants, subsidiaries, and branches,  
as well as authorized distributors and other authorized service and sales facilities throughout the world.**

**Complete address / phone / fax / email information for all locations is available on our website.**